



We do it your **Wayfinding**

## MCFT- Your Guide To Sign Solutions



w w w . v i s t a s y s t e m . c o m

We do it your wayfinding



# Experience The Vista



With Vista System, you get what is expected from a leading international sign manufacturer.

Availability of service through thousands of sign professionals worldwide.

MCFT - Modular Curved Frame Technology: A modular system with the ability to provide highly customizable solutions that meet the unique requirements of each sign project.

A modern, contemporary clean look.

Simple to use and easy to update by yourself.

Maximizing modularity with a wide range of sizes.

Providing a comprehensive solution with an unrivaled range of applications that covers the entire project for a competitive price.

High quality, 100% guaranteed product.



We hope you will enjoy our new guidebook, and find it useful and convenient.

As you may have noticed, we often mention in our literature that we operate according to the U&I business method. The U&I method was developed by us with a specific goal and is our promise to the market.

We strive to continually provide an "Unbelievable & Incredible" experience to our customers with everything we do.

Sounds overstated? Well, we mean it! We realize that our customers expect their service to improve and not decline.

We also understand that's exactly what gets us excited about being in business in the first place. The challenge of discovering just how far we can go to impress you, to excite and surprise you and to improve your well being as a result of doing business with us. Focusing on this goal requires our team to constantly work hard on improving, creating and generating new ideas as to how we can improve your well being. This type of focus and purpose generates a positive atmosphere amongst our company and makes it a great place to be.

We invite you to join our excitement!



10EN-PH3

### Table of Contents:

MCFT.....	4
Vista System Advantages .....	5
WF - Wall Signs .....	6
WFVL - Vista Light Wall Signs .....	13
WB - Projecting Signs .....	16
WBVL - Vista Light Projecting Signs .....	20
D - Directories .....	22
TS - Table Stands .....	28
DS - Double Sided Pylons .....	32
SUS - Suspended Signs .....	36
SUSVL - Suspended Vista Light .....	40
DSP - Double Sided Post Signs .....	42
TRP - Triangular Post Signs .....	44
VLP - Vista Light Post Signs .....	46
TR - Triangular Pylons .....	48
VL - Vista Light Pylons .....	52
Samples and Display Kits .....	57
Bookmarks .....	59

# MCFT

## Modular Curved Frame Technology



10EN-PH4



MCFT is a new concept in the sign industry. MCFT was developed by experienced sign professionals with a goal to fill the gap between custom fabricated sign systems and modular sign systems. MCFT offers the best of both worlds by providing the consumer with all the advantages of a modern modular system, while at the same time, providing a custom solution for the unique requirements of each project. The result, a modular system with a custom fabricated look and capabilities.

MCFT offers flexibility when it comes to budgeting, by offering the ability to adjust the cost according to the level of customization.

What makes an MCFT system?

### Modular

Standard units that can be assembled in different ways using both standard and custom accessories and attachments.

### Curved

Today's design trend and a curved shape that keeps the insert material in place by using its own tension.

### Frame

Enabling the use of many types of sign substrates and inserts providing for easy and inexpensive updating of the signs.

### Technology

With MCFT, the sign-pro participates in the design and development of new ideas for new products and becomes an integral part of the development process jointly with Vista System by providing new ideas from the field that mirror market needs. These demands are supported by the quick fabrication capabilities of custom accessories and attachments that mesh with the system extrusions.

### MCFT - Market position and advantages

	Custom	Modular	MCFT
Create signs with a modern curved shape.	✓	✓	✓
Fast delivery.	-	✓	✓
Can be used with many kinds of sign methods such as: engraving, screen printing, vinyl, photopolymer, ADA, digital printing, etc.	✓	-	✓
Wide range of applications that cover the entire signage project.	✓	✓	✓
Can be used with many kinds of standard sign substrates such as: Plastics, metals, paper, laminates, veneers, etc.	✓	-	✓
Easily update; low cost to update the information without the need of a professional on site.	✓	✓	✓
Dismantles easily for efficient shipping.	✓	✓	✓
Cost efficient!	✓	✓	✓

### Custom Components and MCFT

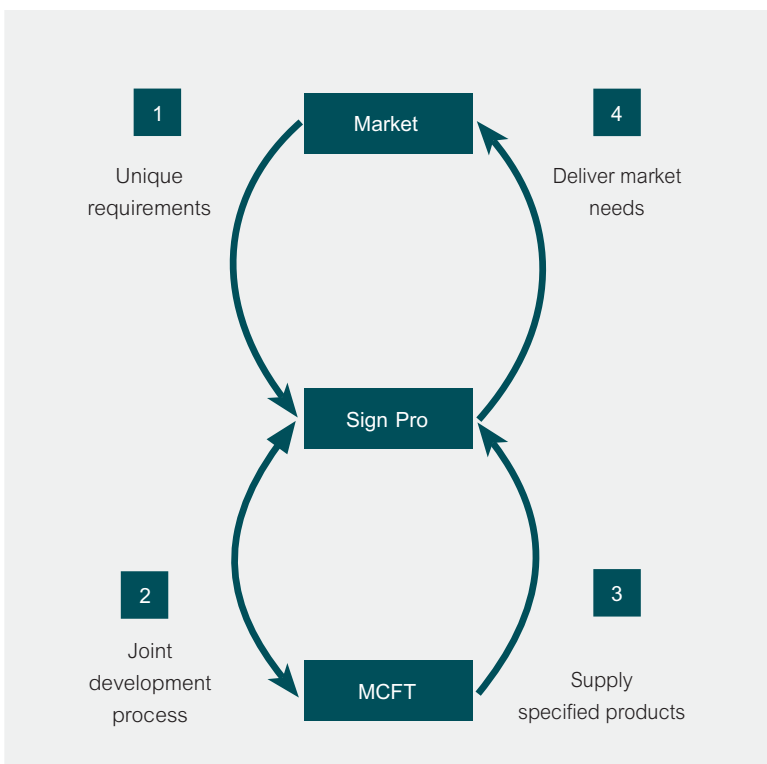

# Vista System Advantages



10EN-PH5

## Sign frame:

Vista System was originally designed as a sign frame holder for a wide range of applications. This gives Vista System a huge advantage over other sign systems. The system is designed to handle most applications and materials used in the sign industry. This includes printed-paper, engraved, embossed, screen-printed substrates, photo-metal, photo-polymer, vinyl graphics, photo-luminescent safety signs, tactile, and more. The materials used include polymers and metals of all types, plastics, paper, etc. Any material with flexibility and the correct thickness may be used as an insert with Vista System frames.

## Easy to adopt:

This means that Vista System is the easiest system for sign companies to adopt. There is no need to develop new technologies, but simply to incorporate existing technologies into the system.

## A wide range of sizes:

Vista System is the only system featuring more than 80 different extrusions, creating unlimited widths and shapes. This is more than five times the number of widths offered by any other MCFT system currently available. This wide choice of sizes and shapes allows the customer to stick to one sign system throughout a project, and to find solutions to almost any kind of sign required.

## Solutions and applications:

Vista System offers comprehensive solutions for suspended signs, flag signs, main directory signs, double sided pylons, triangle pylons, post signs, personal table signs, and many more. No other curved system can offer such a comprehensive solution.

## End caps:

Vista System offers both plastic and metal end caps. The end caps are available with screws for maximum security to avoid vandalism. Plastic caps are made of a custom formulated polymer of unique flexibility and resilience that can be painted. The metal end caps are made of aluminum with silver or black anodized finishes and include stainless steel screws.

## Screw bosses for structural purposes:

Vista System offers a revolutionary solution for attaching and installing signs with no need for the welding and/or building of metal construction for support. A system of massive channels (Screw Bosses) for screws are inside the extrusion itself, enabling the construction of an enormous selection of elements, within minutes and with out any welding or special tools.

## Separation strips:

Vista System offers an integrated system, which allows a sign to be divided into separate changeable slats within one sign.

## Guarantee:

Vista System is sold only under the brand name "Vista", only to the sign trade. Working this way assures sign makers that Vista System will not compete with them and that the project is done by professionals.



## Wall Signs

Create wall-mounted signs with the Vista frame extrusions using any flat, flexible substrate to produce a curved-face sign.

Substrates:

Paper + lens, engraving plastics, thin metals, laminates.

Compatible methods:

Cut vinyl, digitally printed vinyl, engraving, screen-printing and ADA.



10EN-PH6

Extrusion assemblies:

Available from 30mm/1.18" to 1200mm/48" wide.

Plastic end caps: Gray or black, up to V300 excluding V11.

Metal end caps: Brushed silver or black from V60 and up.

Fabric Pin-Mount: A self-adhesive sign holder for Vista signs to be installed on fabric surfaces.

For the System Components catalog, visit our web site: [www.vistasystem.com/Components.html](http://www.vistasystem.com/Components.html)



Vandal resistant

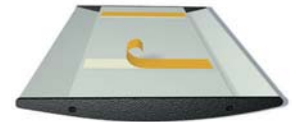

Large mounting surface



Mechanical screw-mount



Flex to insert



10EN-PH6A

Simple to change!

## Fabric Pin Mount



10EN-PH6B

V100

3.84" / 97.5  
3.93" / 100

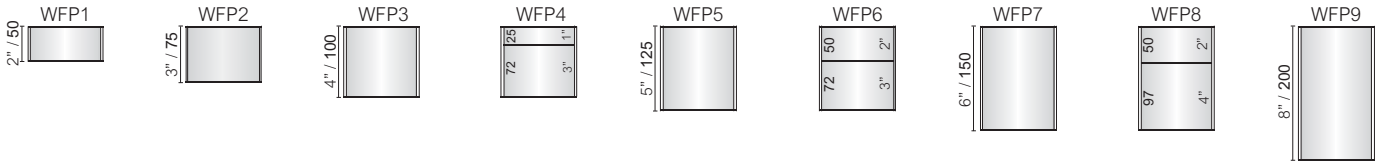

V120

4.72" / 120  
4.72" / 120

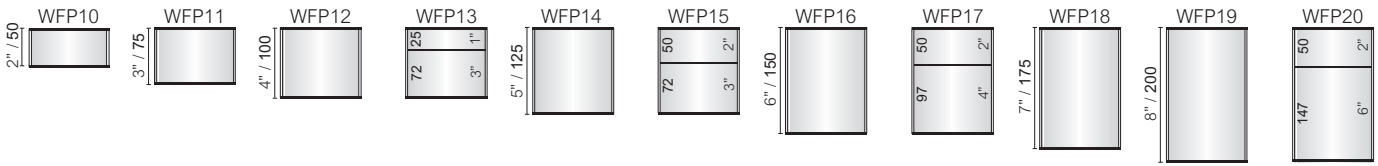

V150

5.826" / 148  
5.90" / 150

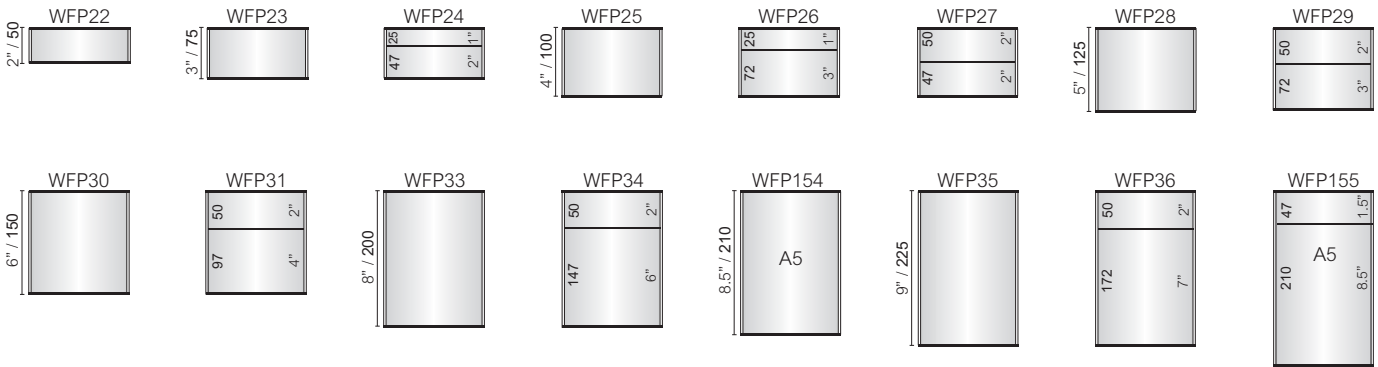

V200

7.8" / 198  
7.87" / 200

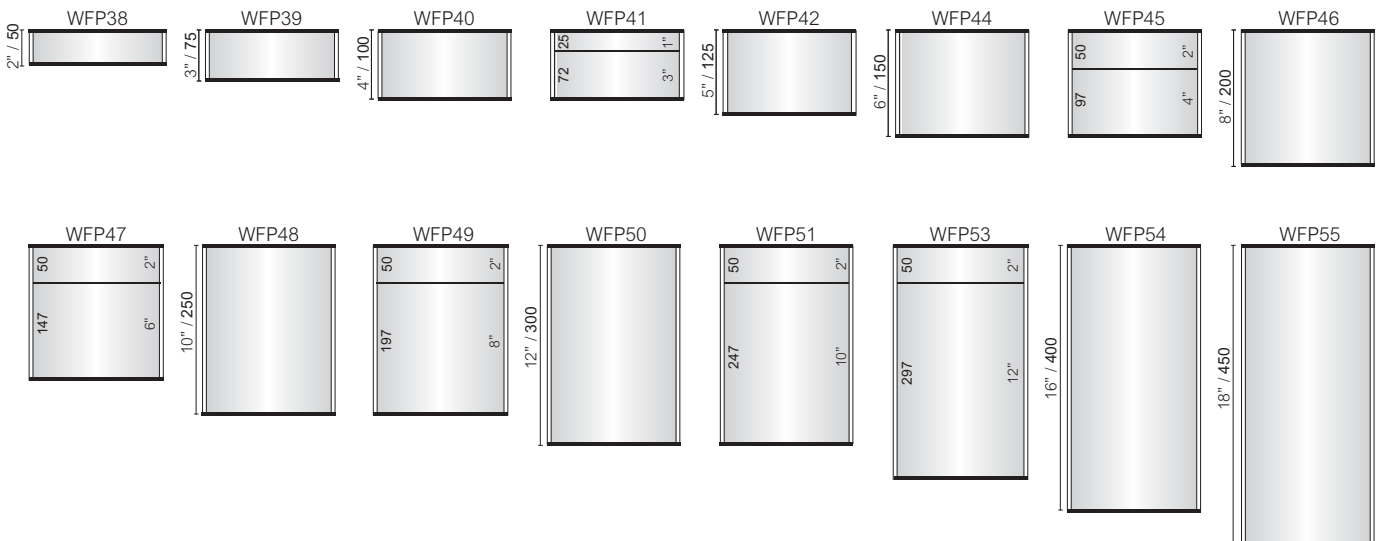

VA4 (210)



VLetter (216)

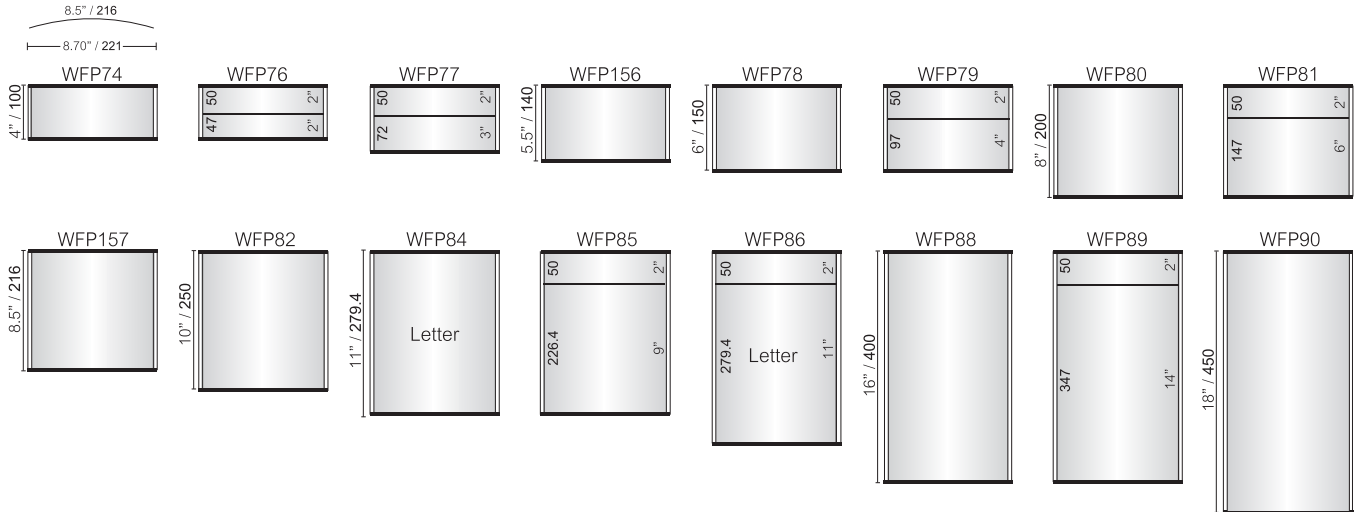

V11 (279)

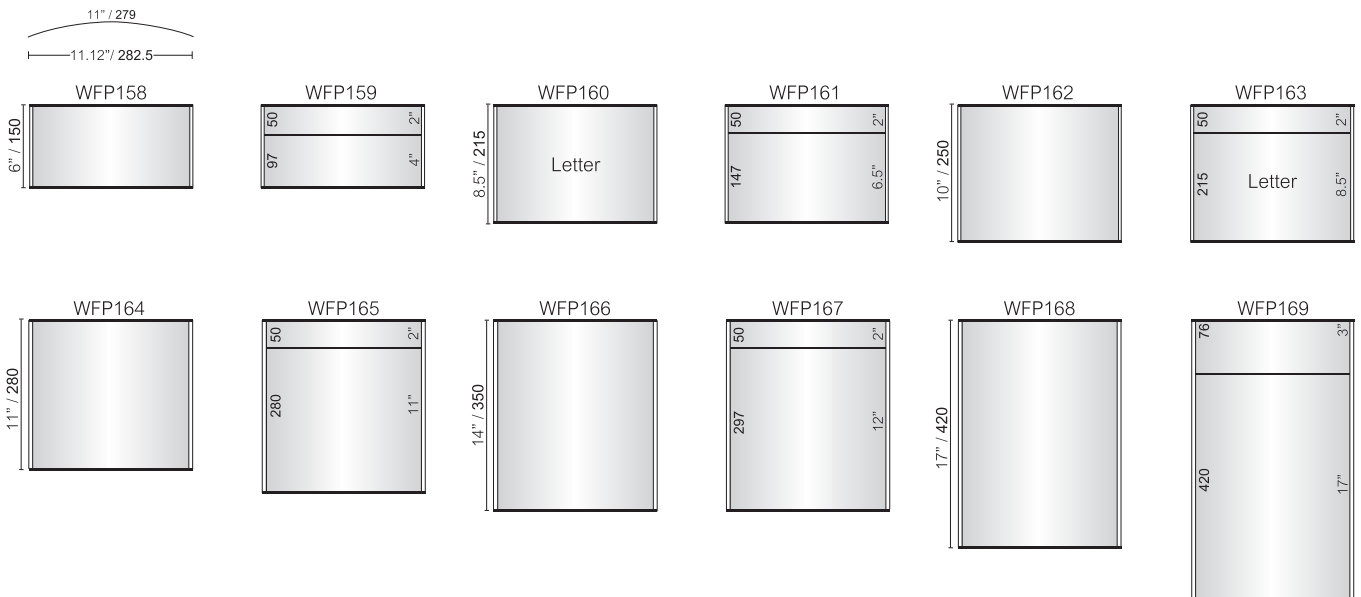



V300 (A3)

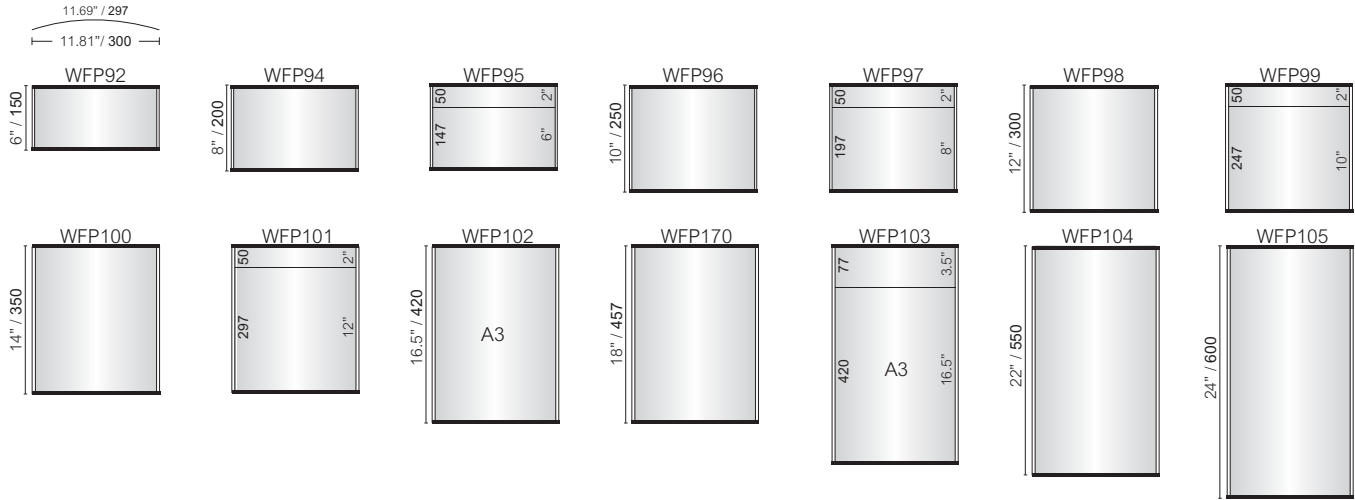

V14 (355)

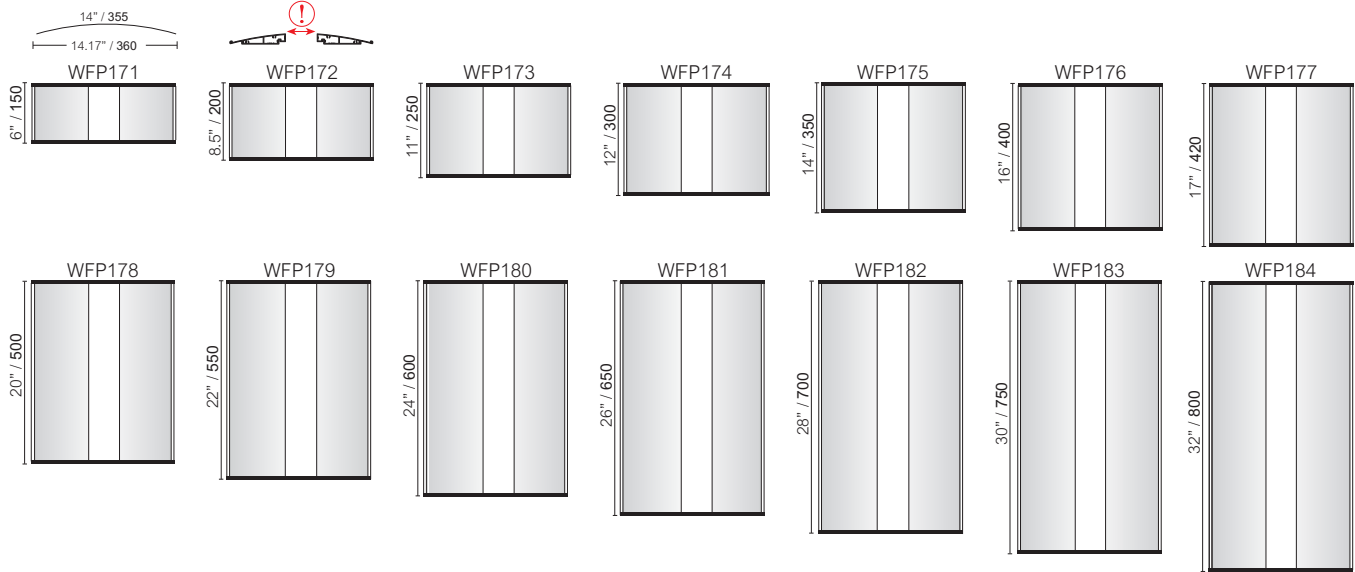

V400

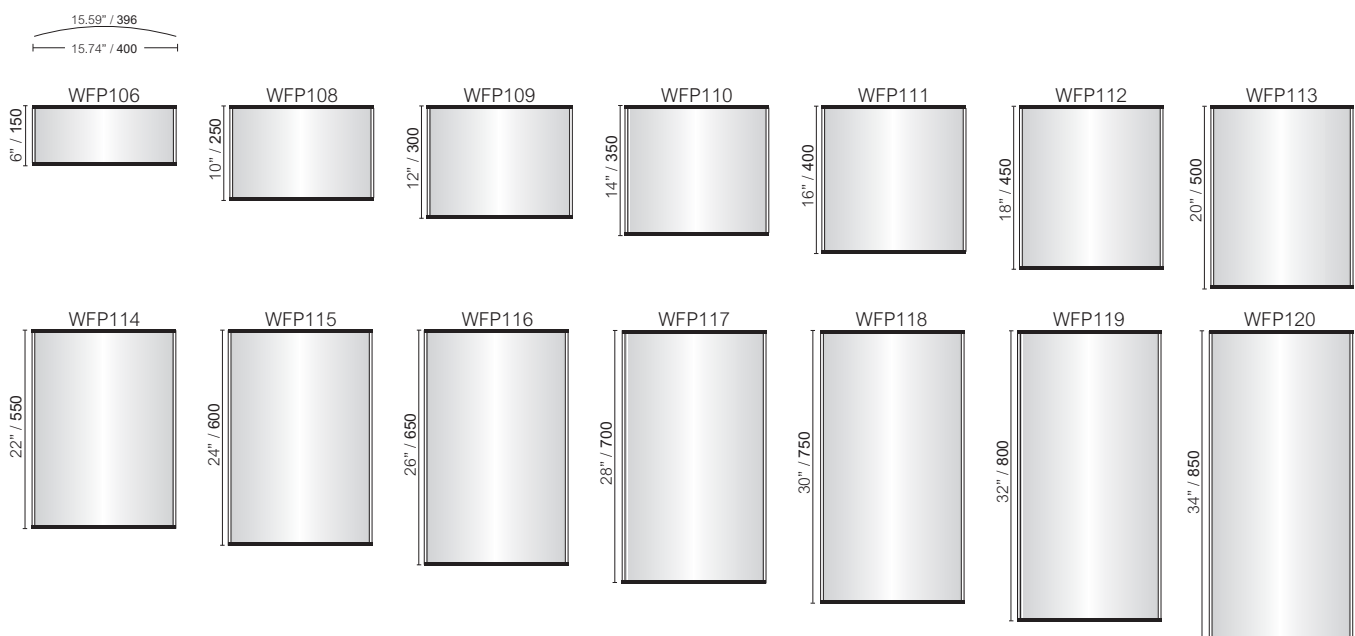

V17 (432)

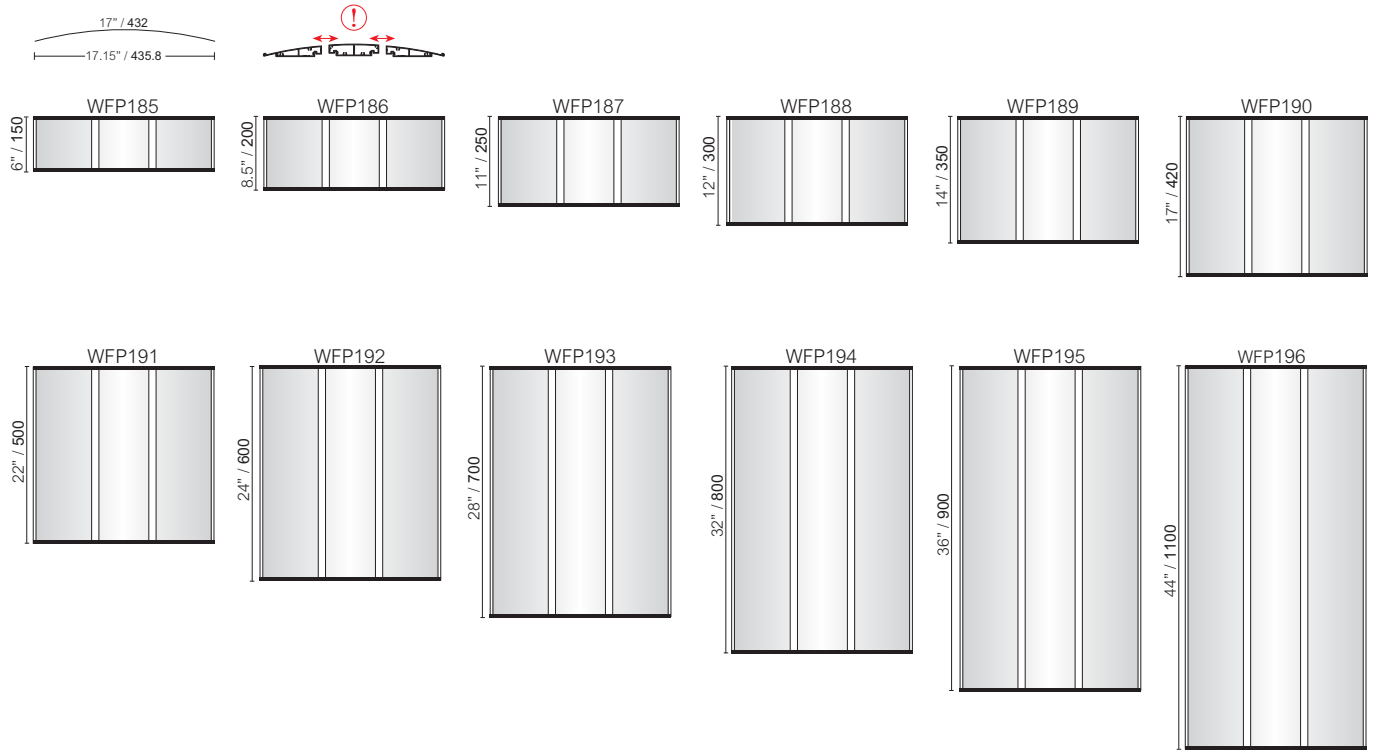

V500

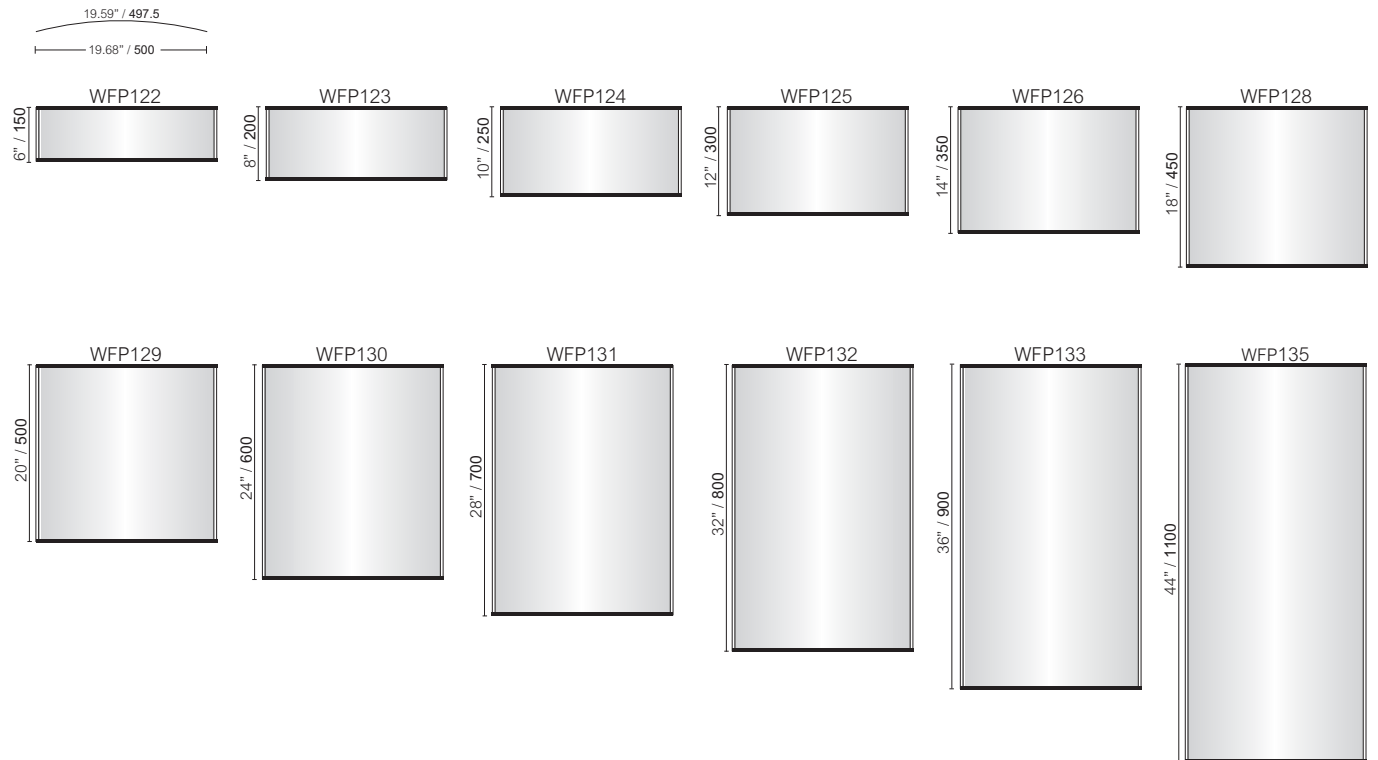

V22 (559)

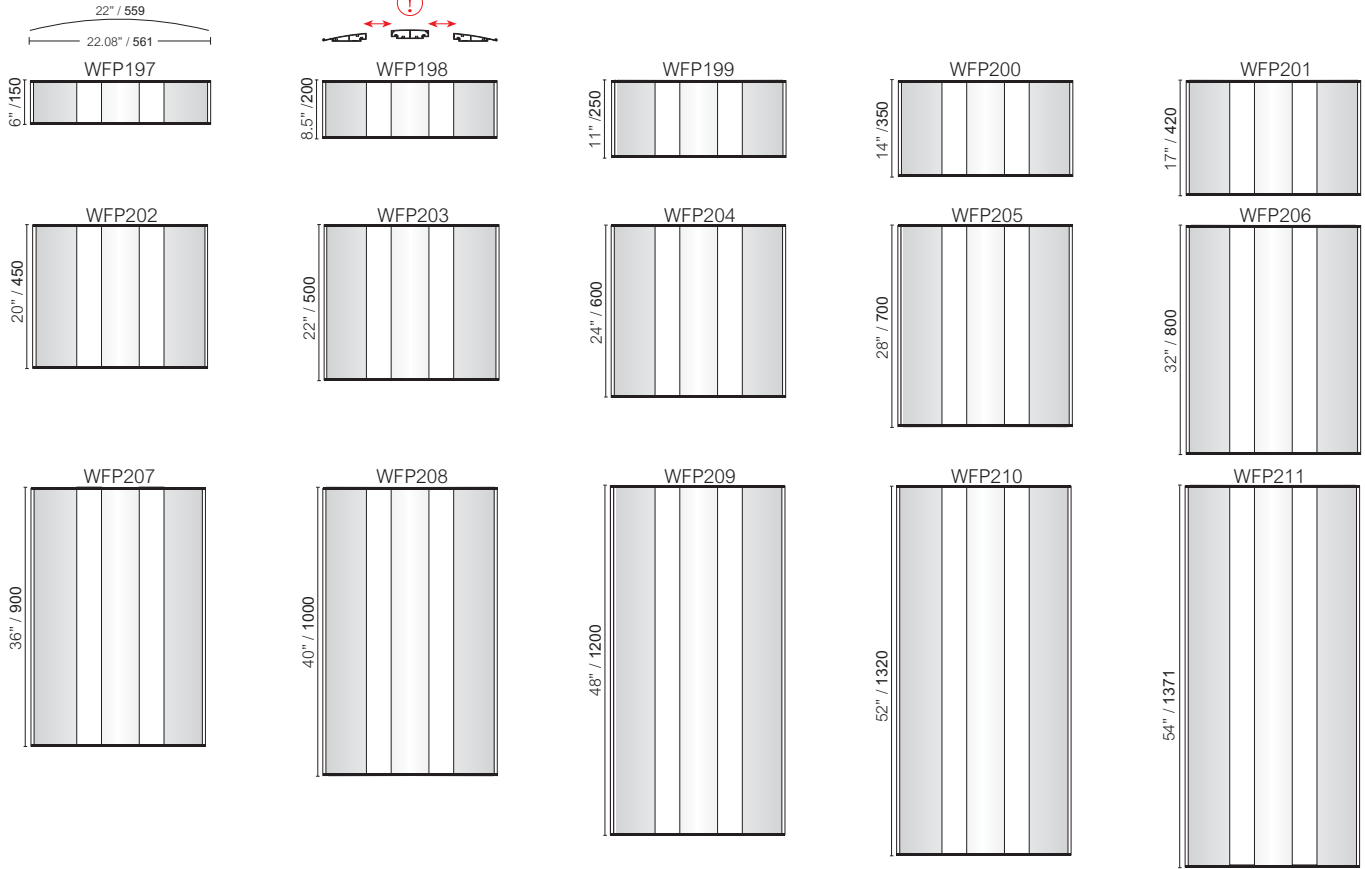

V600

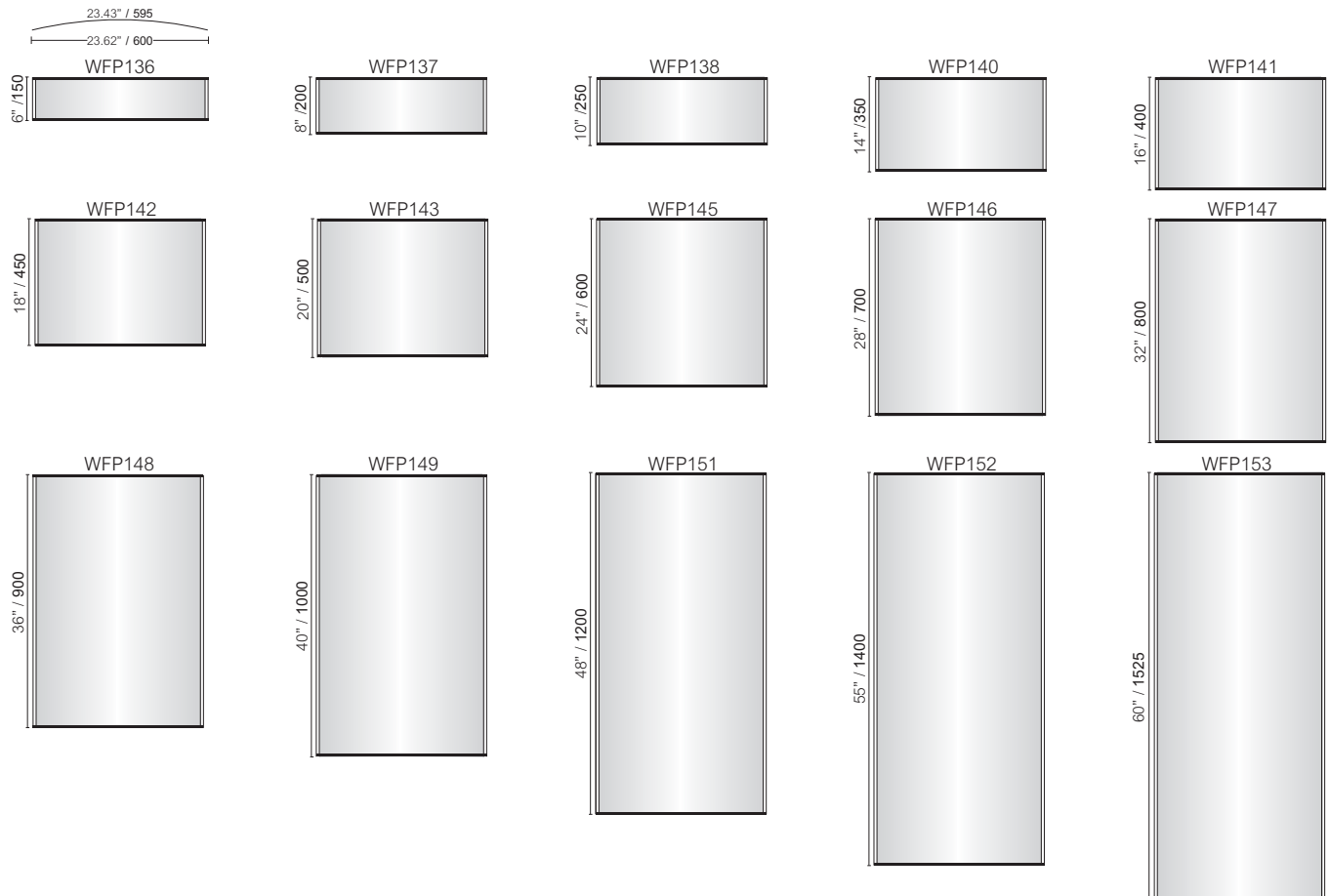

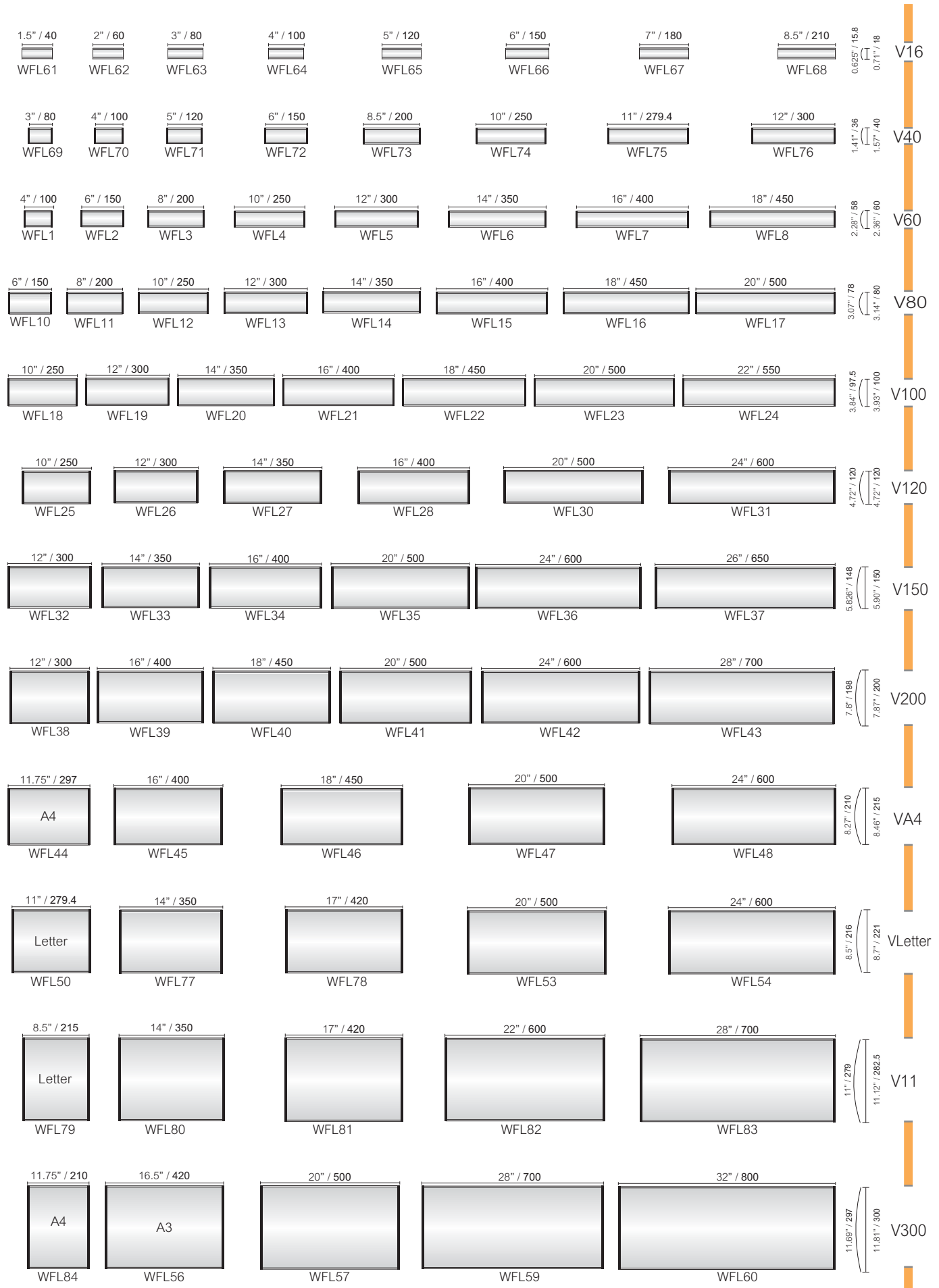

## Vista Light Wall Signs

The Vista Light used with or without lighting, provides the option to sandwich the graphics between a white translucent diffuser and a clear matte lens, both made from vandal proof polycarbonate.

Vista System frames are a perfect solution for posters, and provide POP advertising with enhanced visibility and beauty, thanks to the curved design of the frames. The option of backlit or standard wall frames provides an endless variety of sizes to match any project.



10EN-PH13A



10EN-PH13

Standard finishes for Vista profiles are available in silver or black anodize.

Choose between black plastic end caps or silver and black anodized aluminum end caps.

Custom sizes and finishes are available upon request.



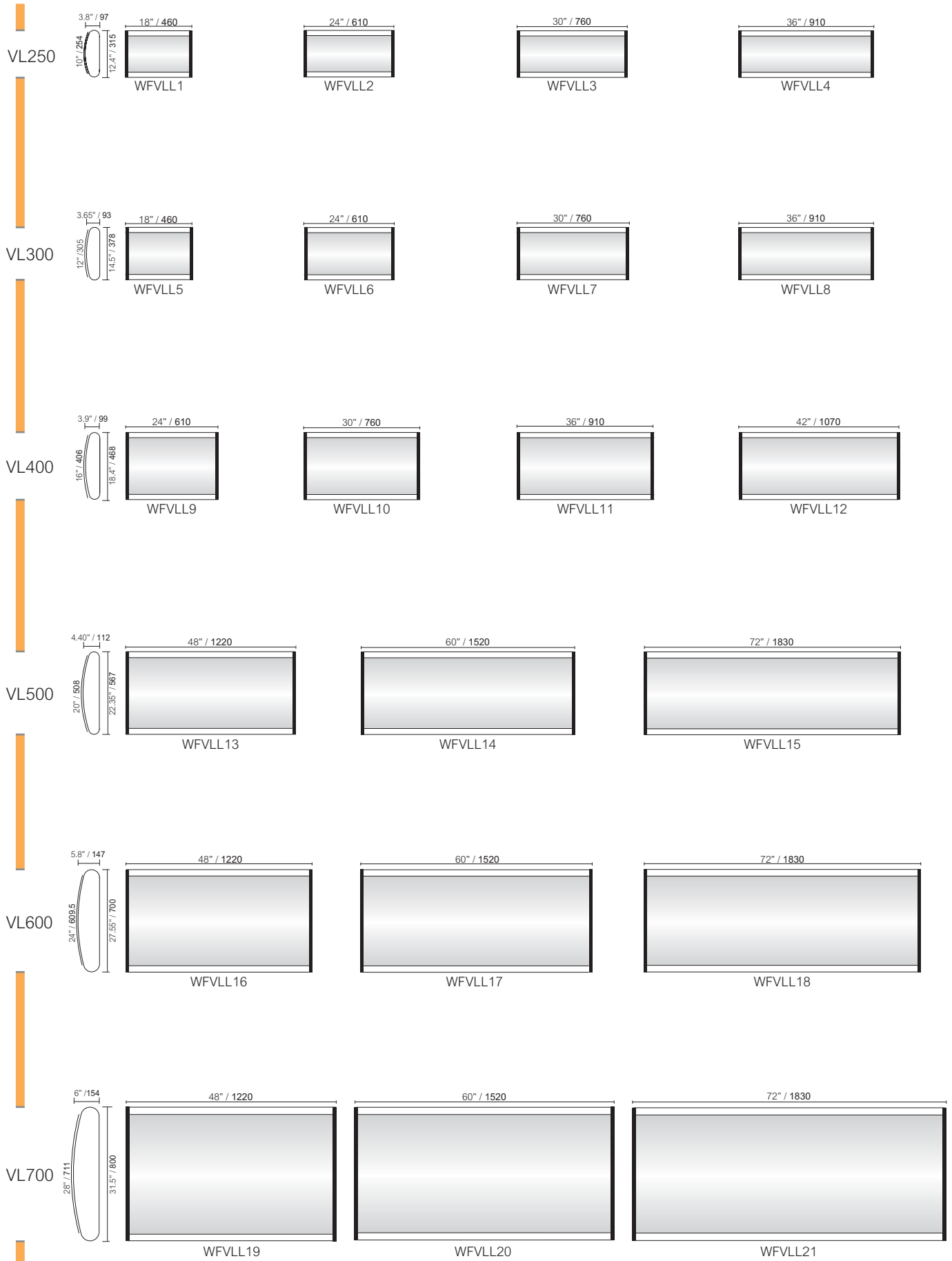

VL400

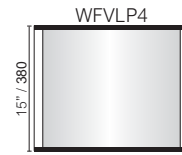
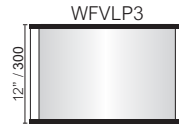
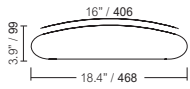

VL500

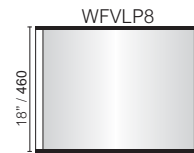
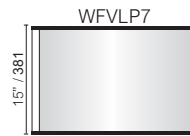
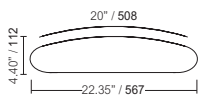

VL600

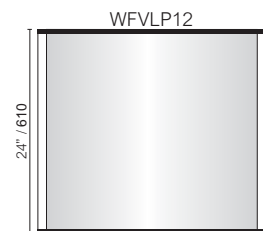
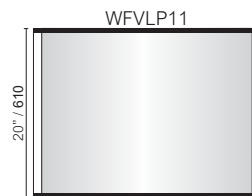
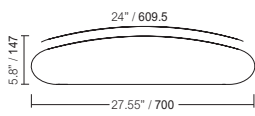

VL700

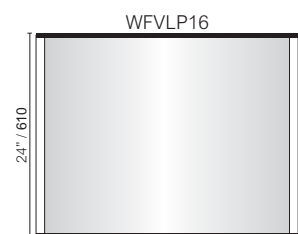
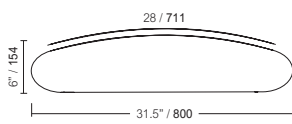

## Projecting Signs

The wall brackets are designed to accept standard size extrusions.

The base is designed to mount on the wall using countersunk screws. The bracket fits on to the base and is secured with decorative nuts. Signs that project more than 4"/100mm into the path of travel, should be mounted at least 80"/2M from the floor.

Choose between standard steel and deluxe aluminum brackets.

Finish: Black powder coat.



10EN-PH16A



10EN-PH16

## Simple Base

The simple base style projecting frames are similar to small pylon signs designed to be mounted flush to the wall. They are attractively priced and provide a clean, streamlined appearance. The simple base design can also be used as an overhead sign mounted to the ceiling.



10EN-PH16B

V100

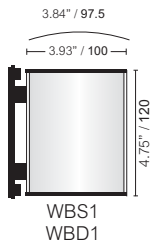

V150

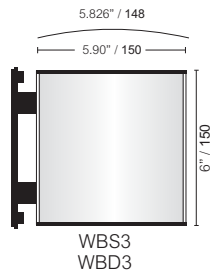

V200

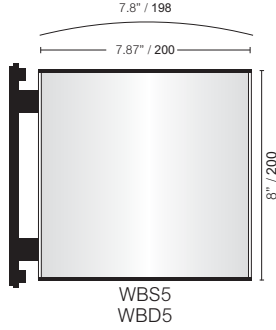

VA4

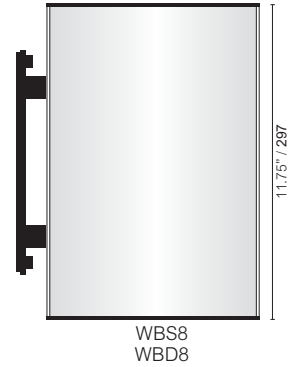
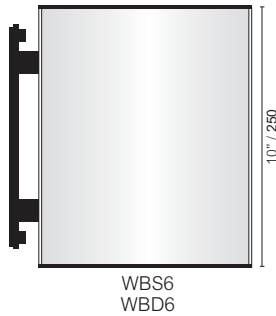
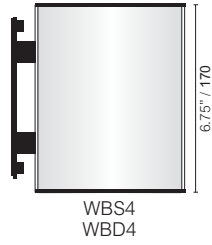
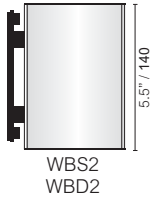
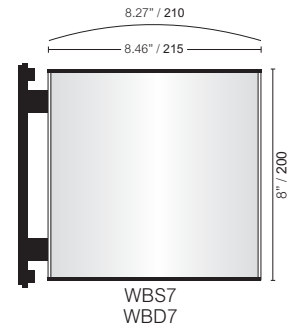

WBD = Deluxe    WBS = Standard

VLetter

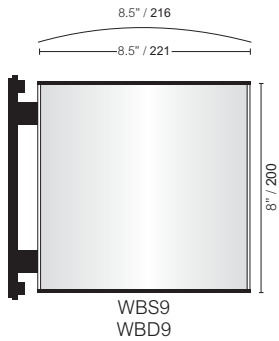

V11

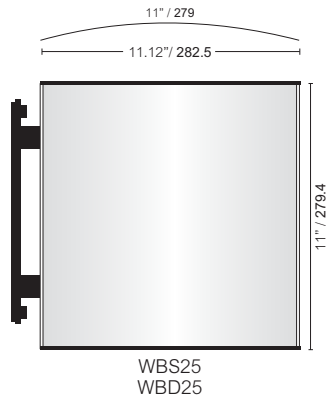

V300

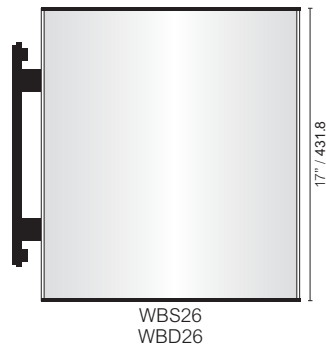
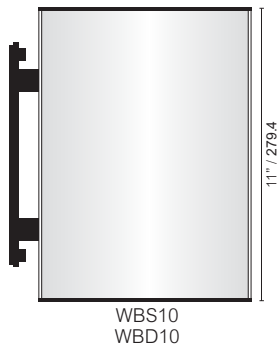
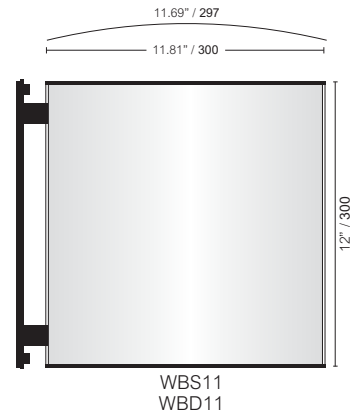

V400

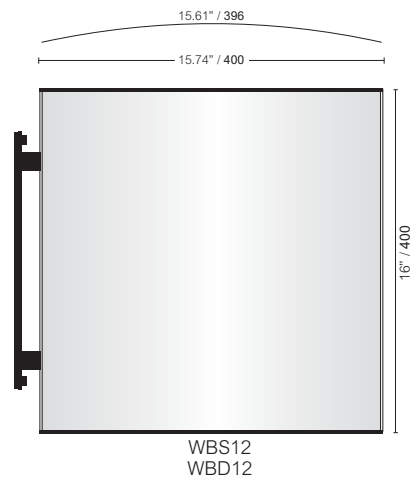

WBD = Deluxe    WBS = Standard

WBD = Deluxe    WBS = Standard

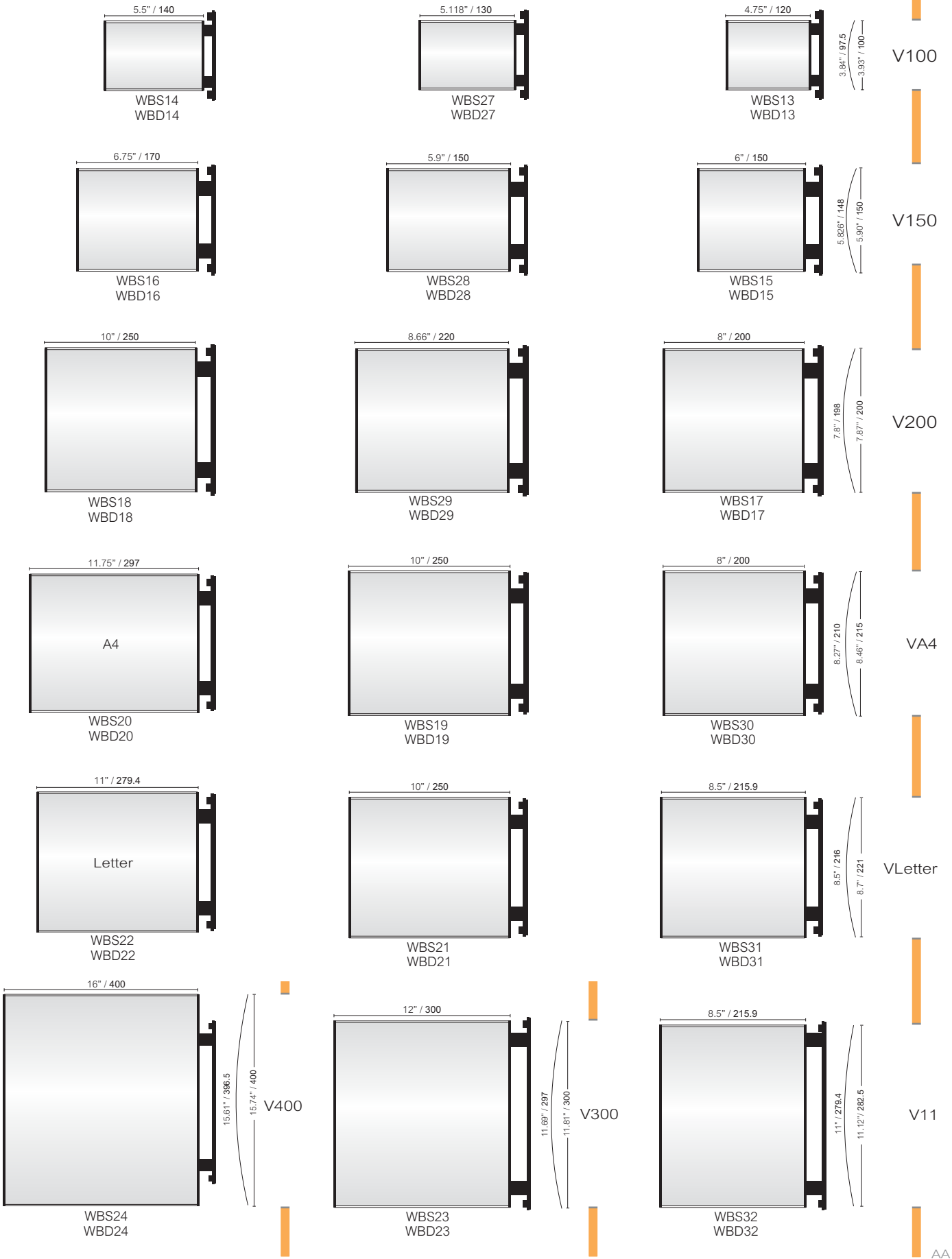



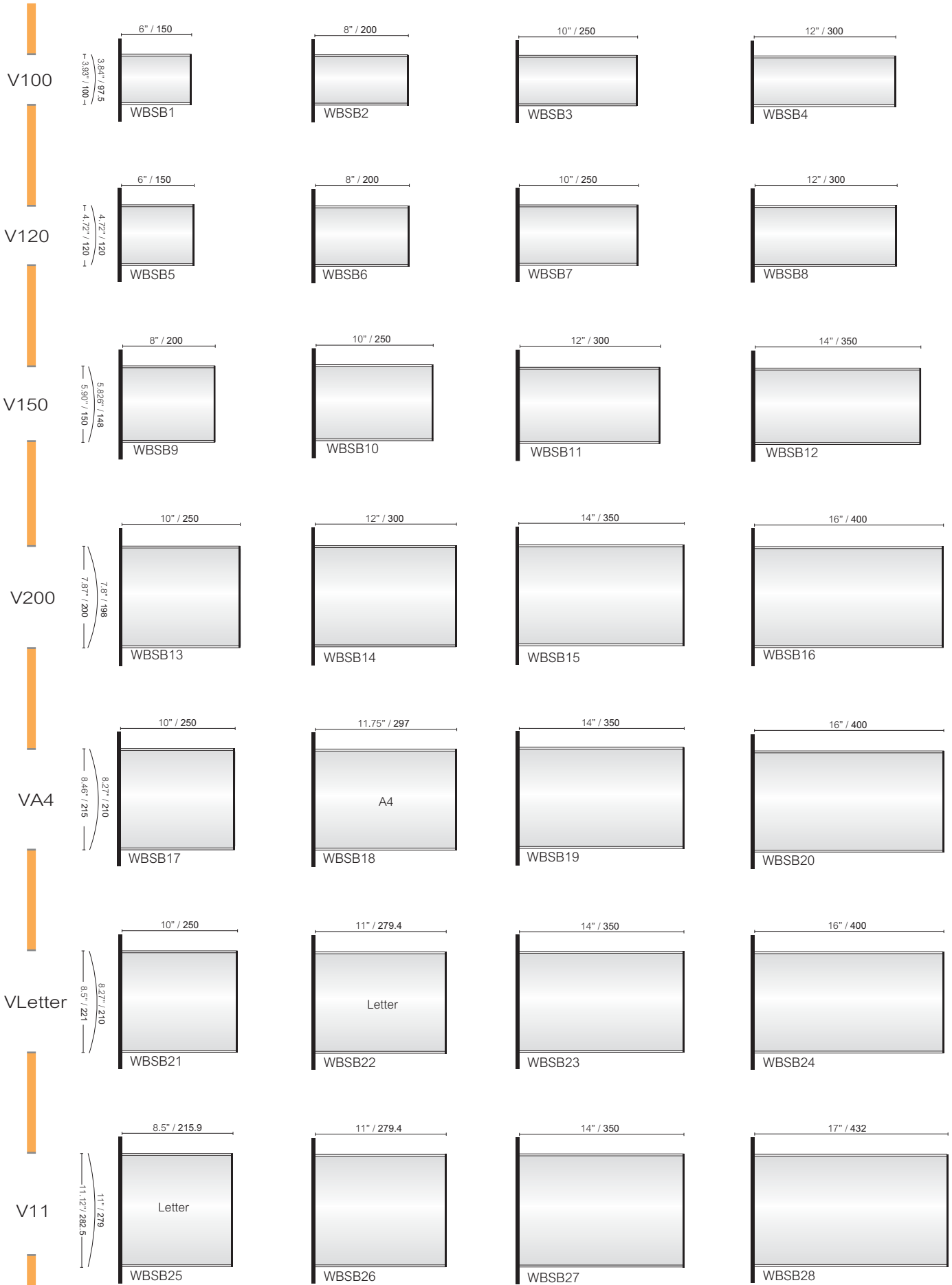

## Vista Light Projecting Signs

The new projecting Vista Light signs can be internally illuminated or used with virtually any sign substrate without illumination.

The Vista Light projecting frames are like small pylon signs. They are attractively priced and provide a clean, streamlined appearance and can also be used as an overhead sign mounted to the ceiling.



10EN-PH20

Standard finishes for Vista profiles are available in silver or black anodize. Choose between black plastic end caps or silver and black anodized aluminum end caps. Custom sizes and finishes are available upon request.

10EN-PH20A

VL250

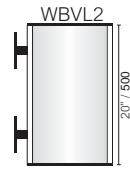
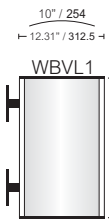

VL300

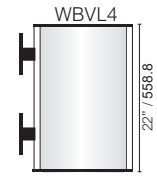
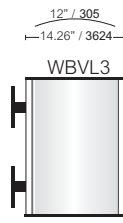

VL400

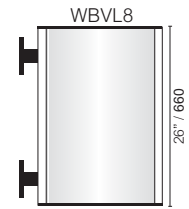
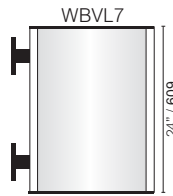
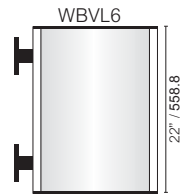
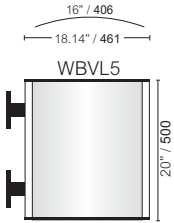

VL500

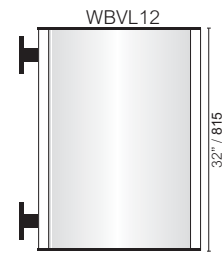
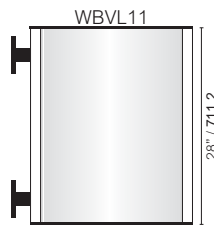
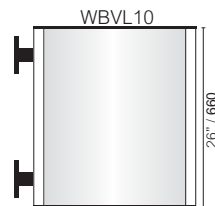
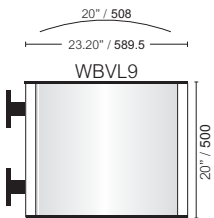

VL600

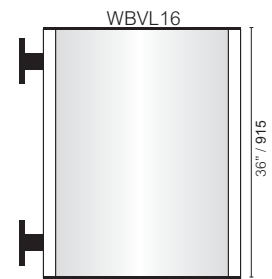
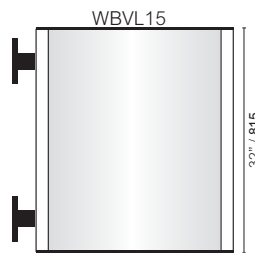
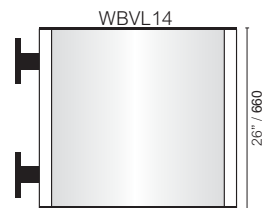
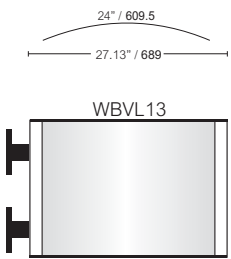

VL700

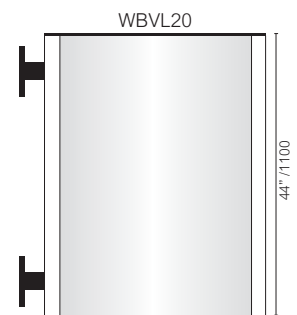
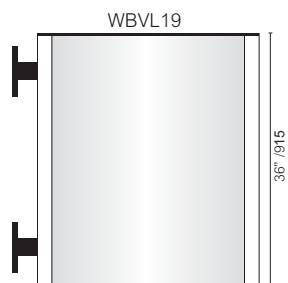
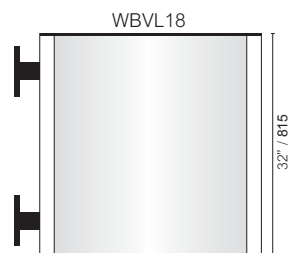
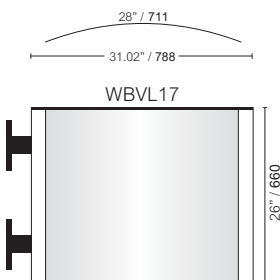

## Directories

Vista System directories are fast, easy and simple to assemble and install. There is no need for special tools. The system has the advantage of flexibility to accept a variety of insert materials as well as the complete freedom to determine the height of each information strip, you decide how the sign will be sectioned by placing the separation strips as needed. Where? Wherever you decide, according to your design.

Building directories with the Vista System's Modular Curved Frame technology is easy!

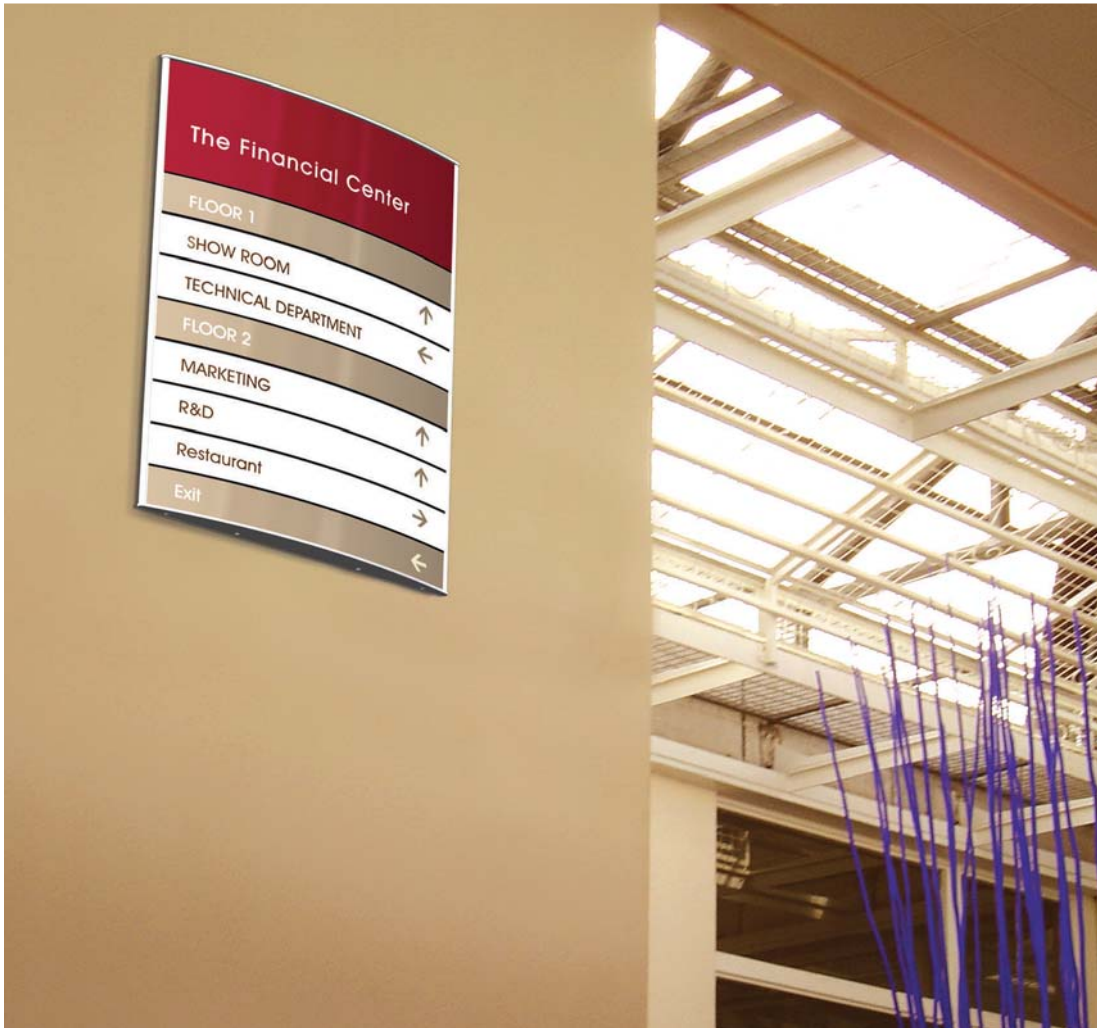

10EN-PH22



10EN-PH22A

Directory assemblies are available up to V600 (24")  
Plastic end caps: Gray or black, up to V300 excluding V11.  
Metal end caps: Brushed silver or black anodize.  
V14, V17 and V22 are not available with separation strips.

For the System Components catalog, visit our web site: [www.vistasystem.com/Components.html](http://www.vistasystem.com/Components.html)

V11 (279)

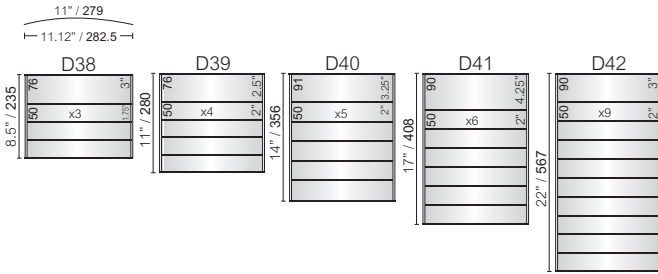

V300 (A3)

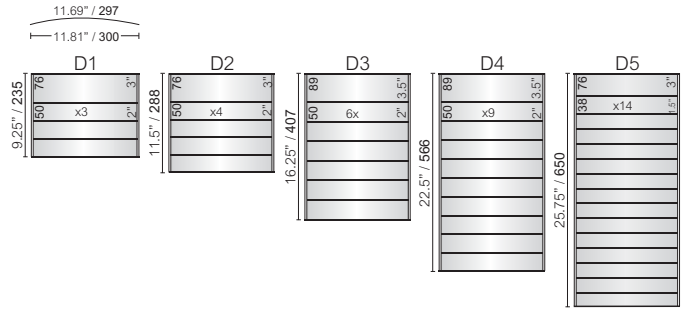

V400

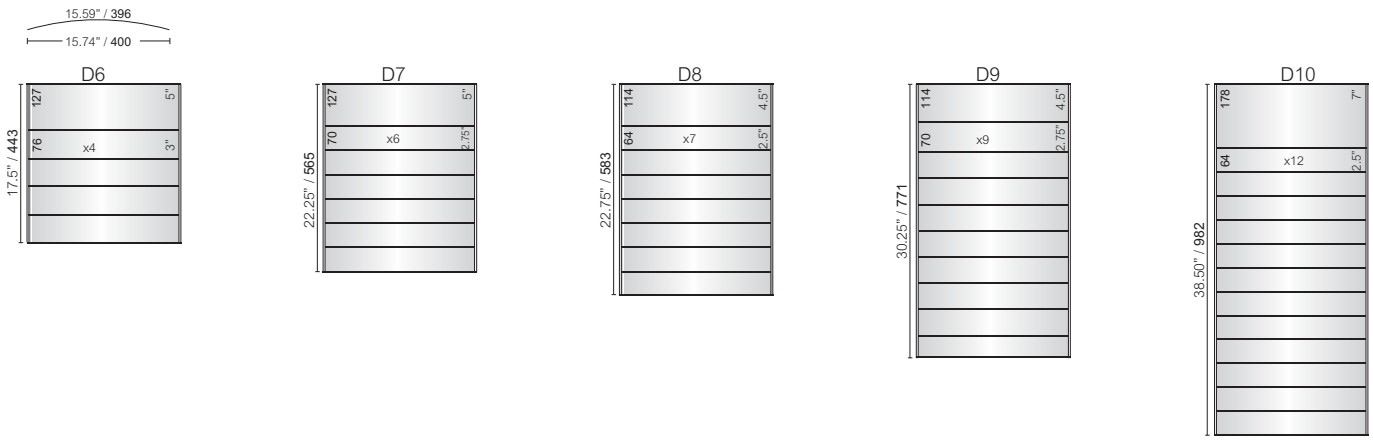

V500

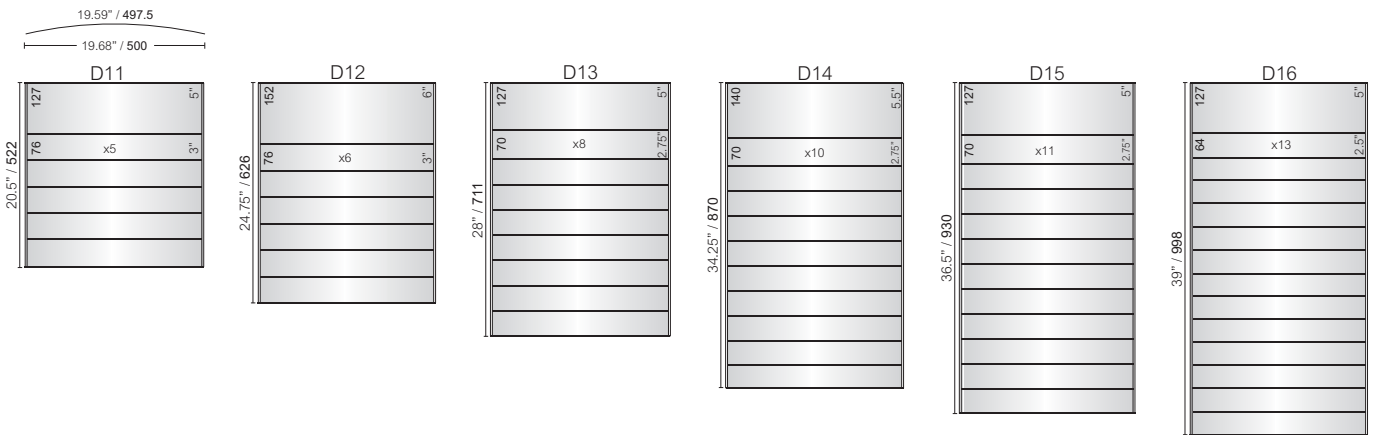

V600

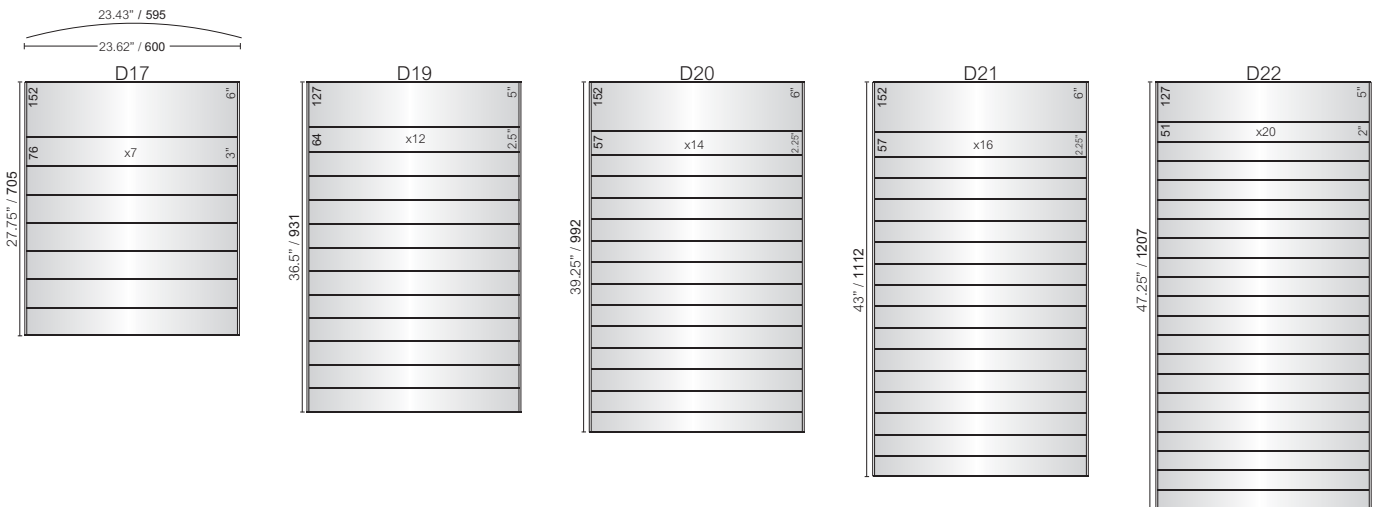



## The Flush Mounted Multi-Panel Directory

This directory is a combination of a number of basic frames, mounted in proximity to each other.

This attractive multi panel directory was created using individual inexpensive elements and clever artwork.

Social Sciences		
000 Generalities	100 Philosophy	200 Religion
000 Generalities	100 Philosophy & Psychology	200 Social Sciences
010 Bibliography	110 Metaphysics	210 Statistics
020 Library & information science	120 Epistemology, causation, historic	220 Political science
030 General encyclopedias	130 Paranormal phenomenon	230 Economics
040 Not used	140 Specific philosophical schools	240 Law
050 General serial publications	150 Psychology	250 Public administration & military science
060 Organizations	160 Logic	260 Social programs & services
070 Journalism, publishing, media	170 Ethics	270 Education
080 General collections	180 Ancient, medieval, Oriental philosophy	280 Commerce
090 Manuscripts & rare books	190 Modern western philosophy	290 Customs, etiquette, folklore

10EN-PH24

### Separation strips:

Vista System offers an integrated system, which allows a sign to be divided into separate changeable slats within one sign.

V14, V17 and V22 are not available with separation strips.

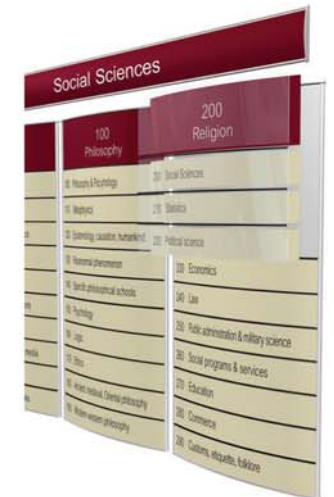

10EN-PH24A

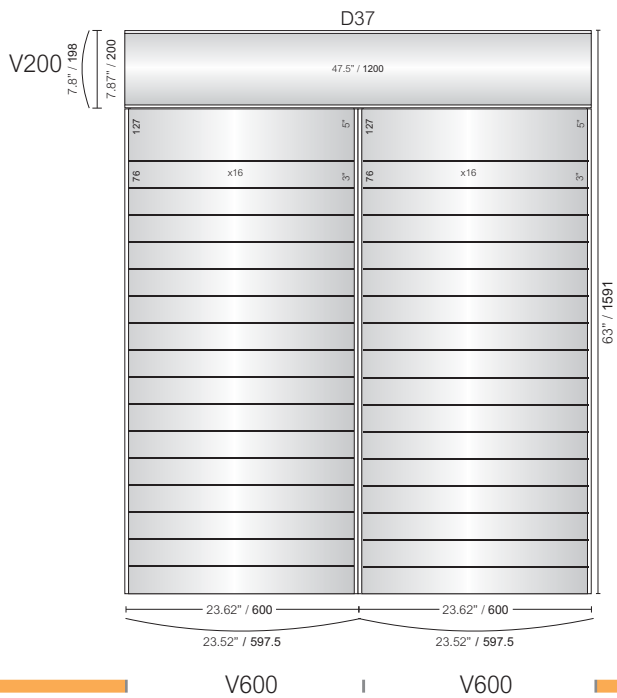
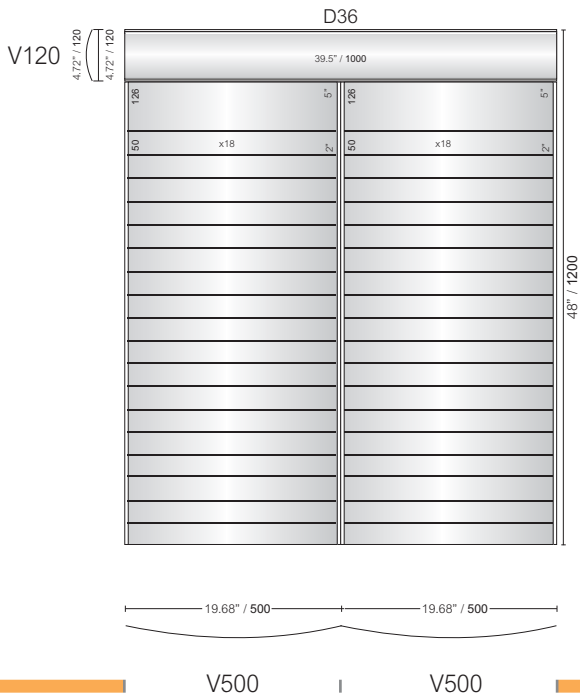
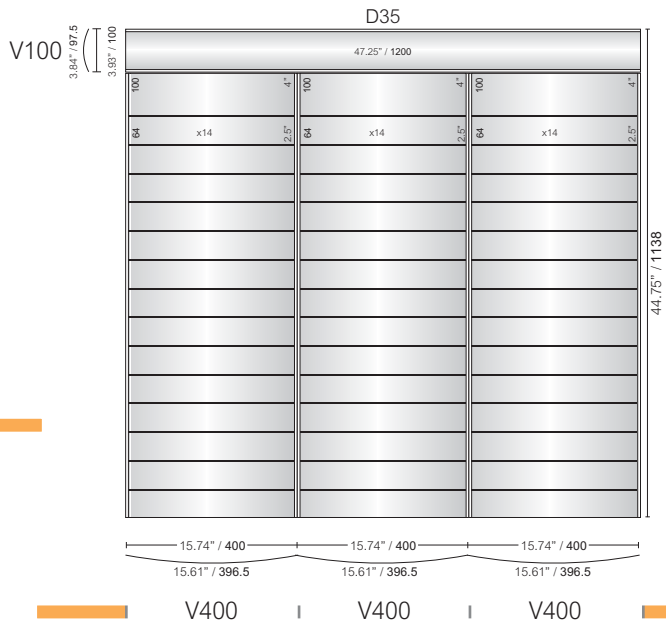
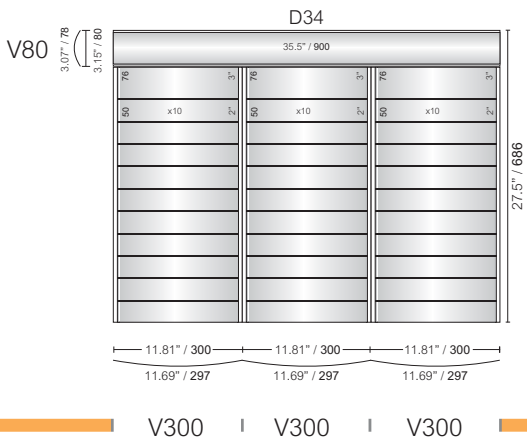
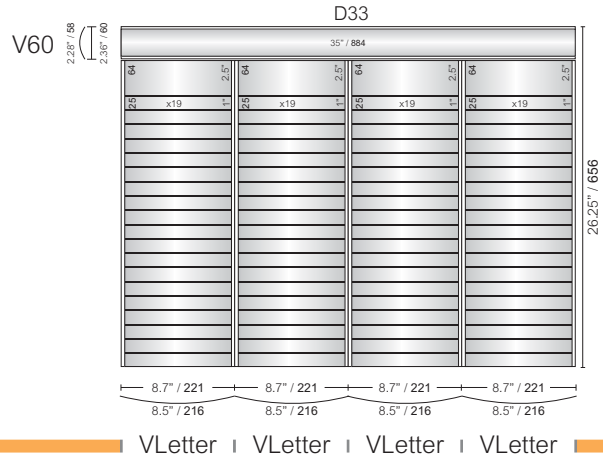
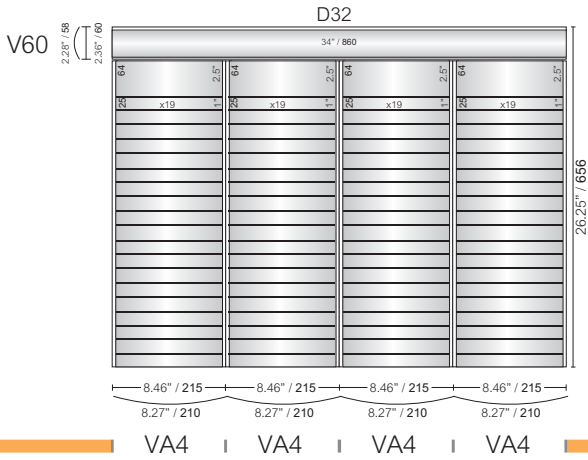

## Directories

Vista System directory signs are easy to maintain and update.

The advantages of this simple system are flexibility when it comes to the overall width of the sign and the ability to add additional panels. It offers a perfect choice, since its' innovative design allows for easy installation, removal and replacement of the signage, even by a novice. Vista's wide-ranging system of contemporary curved framed technology is a key factor in the purchasing process.



10EN-PH26A



10EN-PH26

Plastic end caps: Gray or black, up to V300 excluding V11.  
Metal end caps: Brushed silver or black anodize, from V60.  
Custom sizes, paint or anodize, are available.

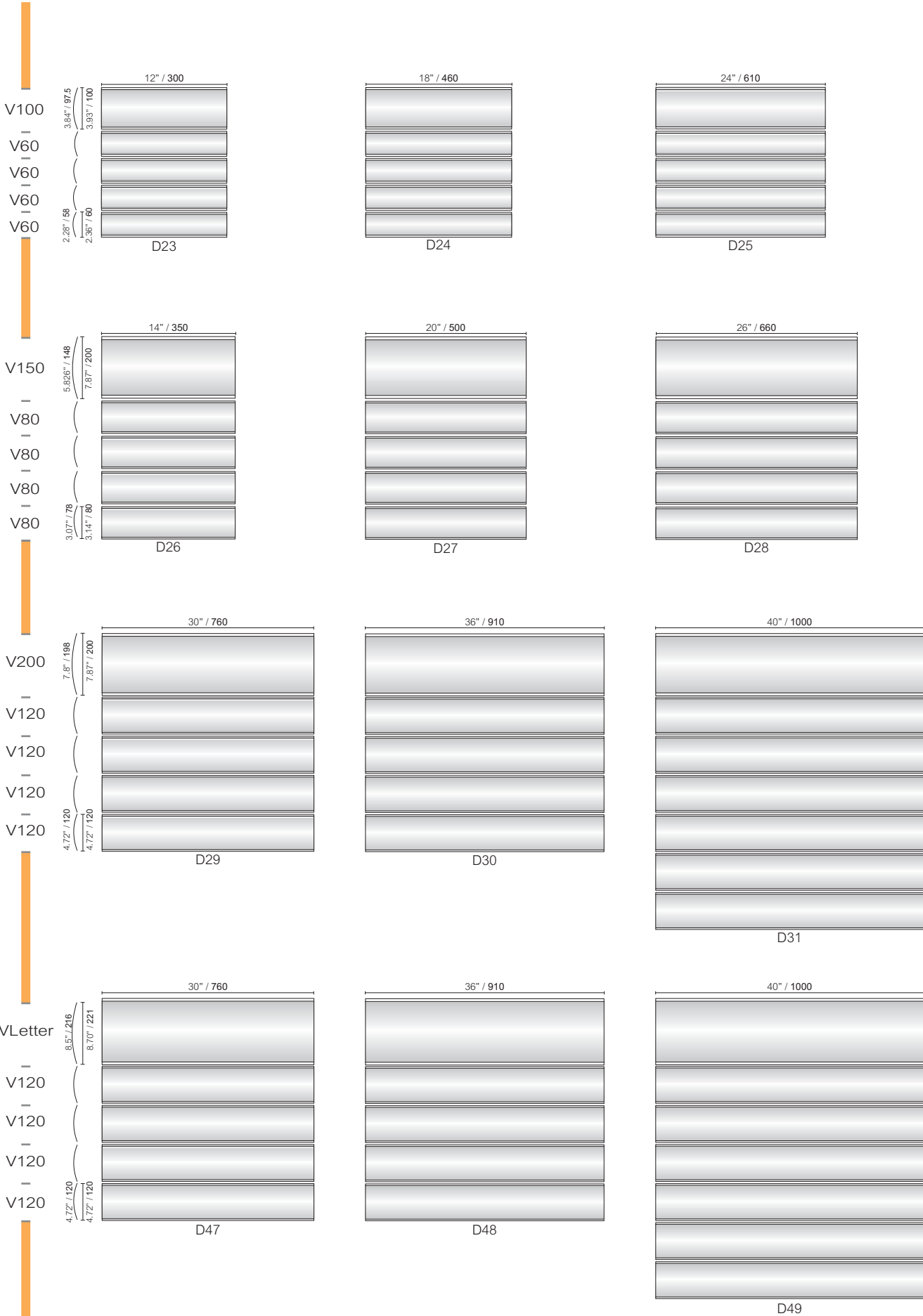



## Table Stands

The “Kangaroo” table sign frame is offered as a complete package:

- Convex frame, aluminum base and end cap, clear/non-glare lens.
- Available in several sizes.
- Easy to assemble.
- Easy to change insert.
- Designed to accept standard paper or other sign substrates.

The Kangaroo sign frame offered in 10 different widths:

V60, V80, V100, V120, V150, V200, VA4, VLetter, V11, V300.



10EN-PH28

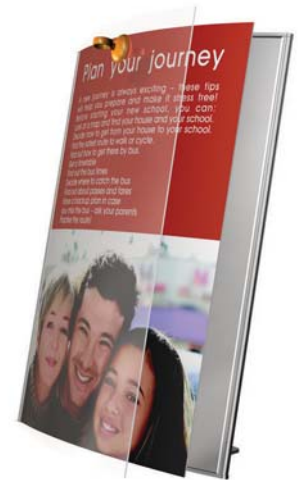

10EN-PH28A

Standard finishes for Vista profiles and metal end caps are available in silver or black anodize.

Custom sizes and finishes are available upon request.

V60

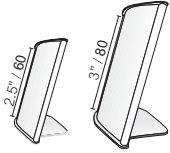
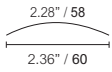

T1 T2

V80

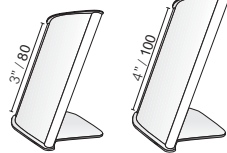
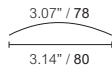

T3 T4

V100

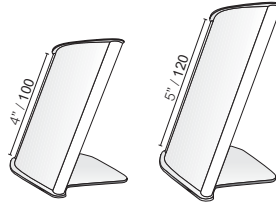
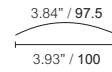

T5 T6

V120

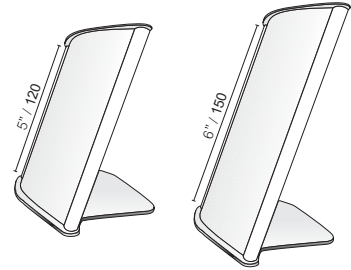
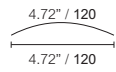

T7 T8

V150

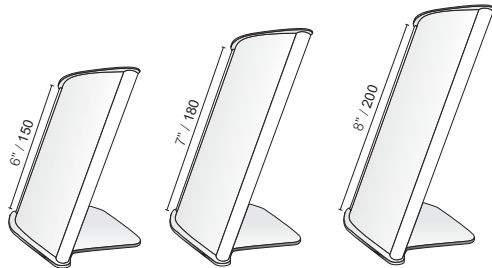
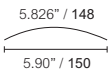

T9 T10 T11

V200

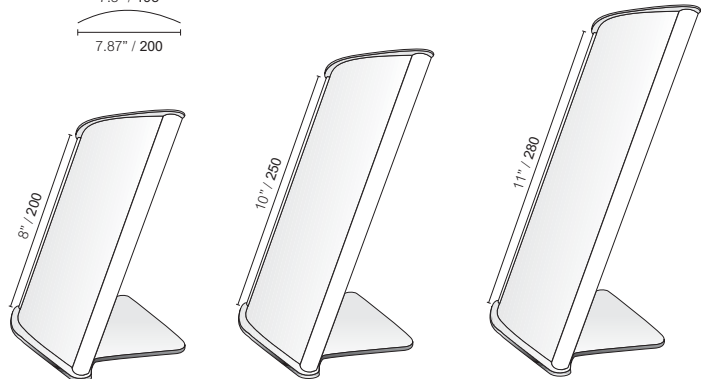
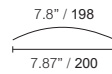

T12 T13 T14

VA4

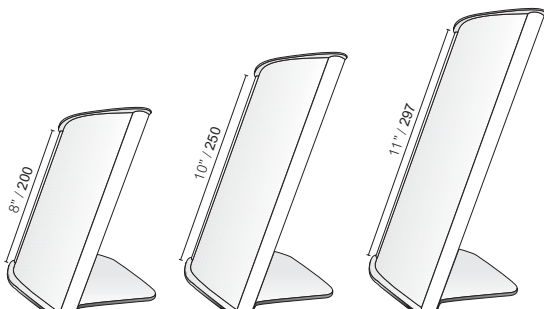
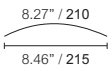

T15 T16 T17

V300

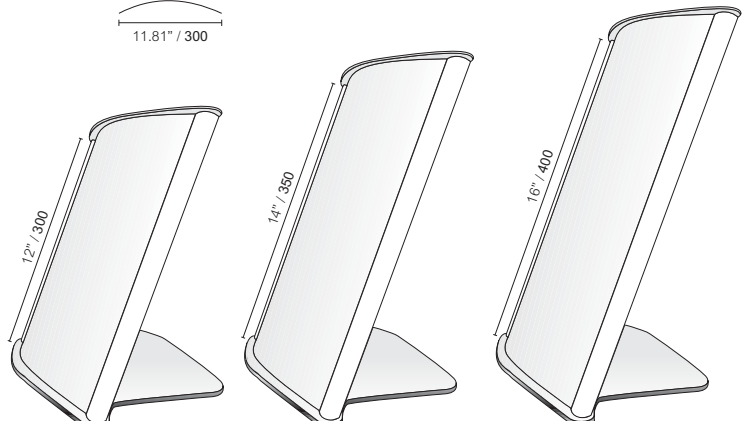
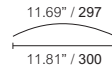

T18 T19 T20

VLetter

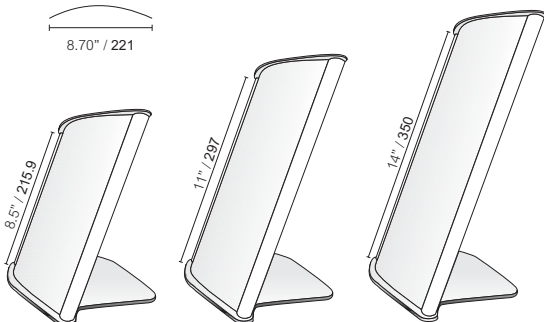
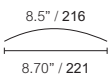

T45 T46 T47

V11<sup>(279)</sup>

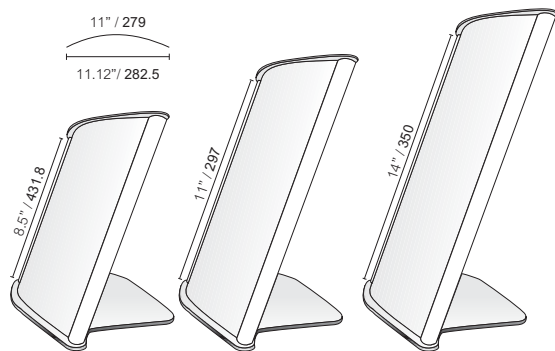
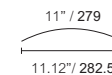

T48 T49 T50

## Table Stands

The "Boomerang" sign frame is offered as a complete package:

- Convex frame, end caps, clear/non glare lenses.
- Available in several sizes.
- Easy to assemble.
- Easy to change insert.

Frames are offered in 10 different heights up to V300. Standard finishes are available in silver or black anodize. Custom sizes and finishes are available upon request.



10EN-PH30

## TS30

The TS30 is a three sided heavy table sign, offered as a complete package: 30mm/1.18" per side.

Plastic end caps are available in gray or black, supplied with three clear non-glare lenses.



10EN-PH30A

The TS30 is available in clear or black anodize.



10EN-PH30B



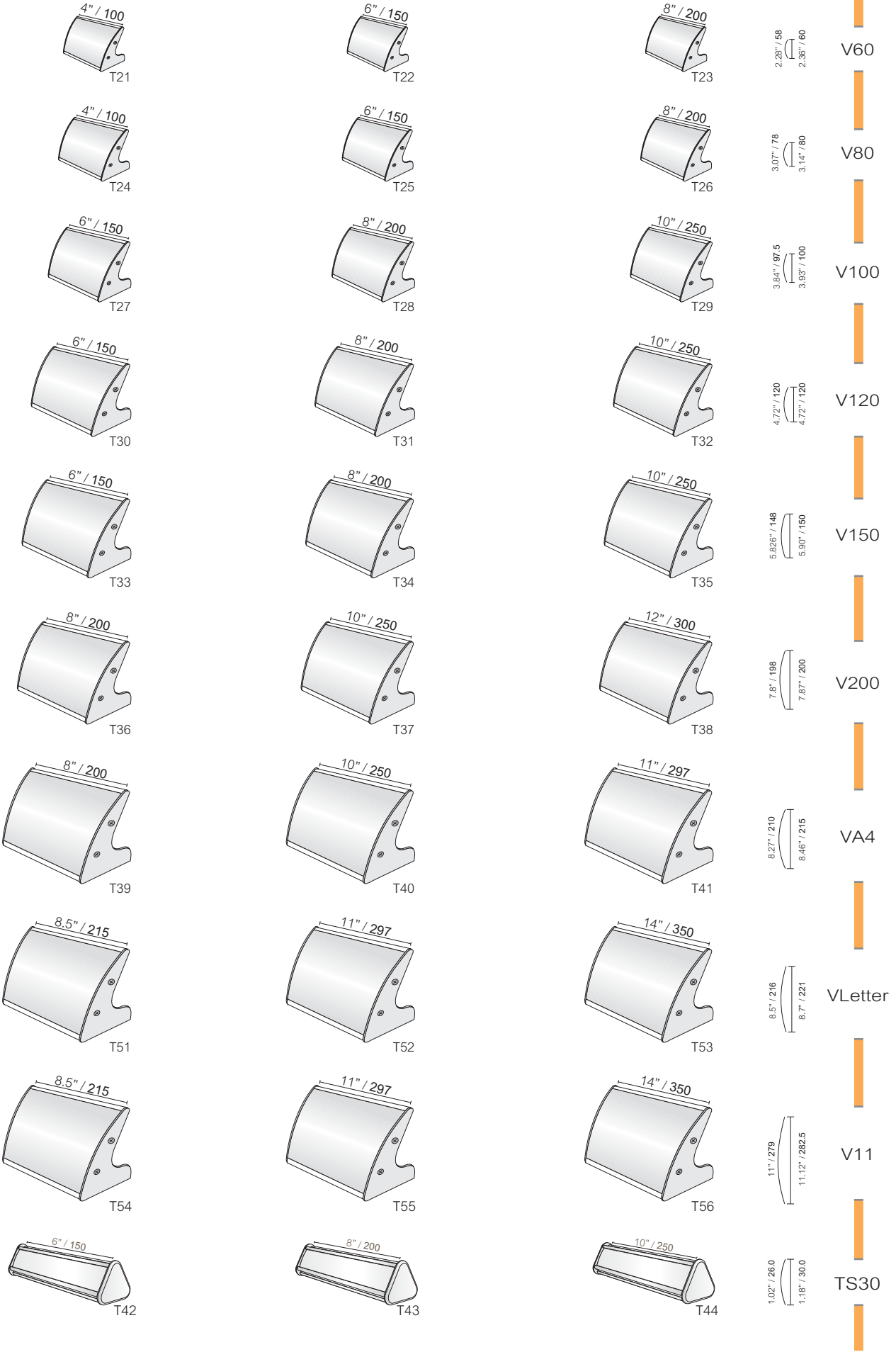

## Double Sided Pylons

The system will accept a variety of standard inserts/substrates, including: paper, plastic, metal, laminates, sublimations, etc...

By adding Vista System divider strips, the towers can function as directories with changeable inserts.

Available in two basic designs:

The slim design is offered in 13 different widths from 150mm/6" to 600mm/24", and can be ordered in various heights to accommodate a wide range of applications. Bases are available for both permanent and portable applications.



10EN-PH32

Great for directories, show rooms, lobbies and displays in many environments, including car parks, airports, hospitals, office buildings, campuses, libraries and more!

Wide design - DSW



Slim design - DSS



10EN-PH32A



Slim design - DSS



Wide design - DSW

VA4

VLETTER

V300

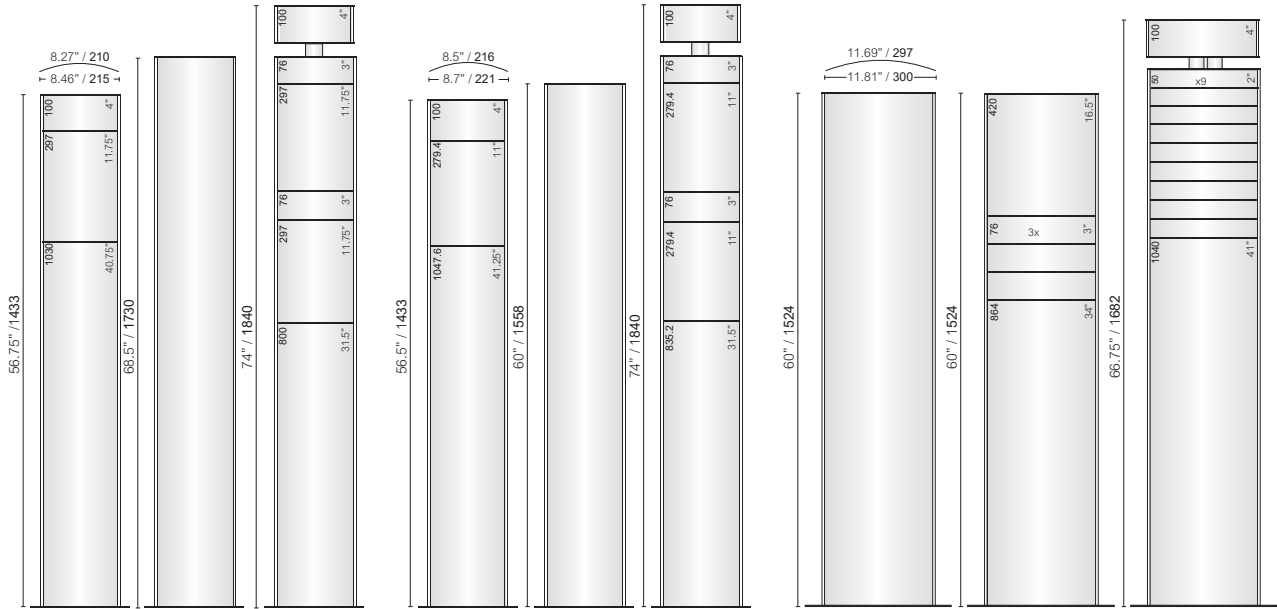

Floor mounted	DSS1 DSW1	DSS2 DSW2	- DSW3	DSS4 DSW4	DSS5 DSW5	- DSW6	DSS7 DSW7	DSS8 DSW8	- DSW9
Free standing	DSS1SA DSW1SA	DSS2SA DSW2SA	- DSW3SA	DSS4SA DSW4SA	DSS5SA DSW5SA	- DSW6SA	DSS7SA DSW7SA	DSS8SA DSW8SA	- DSW9SA

V400

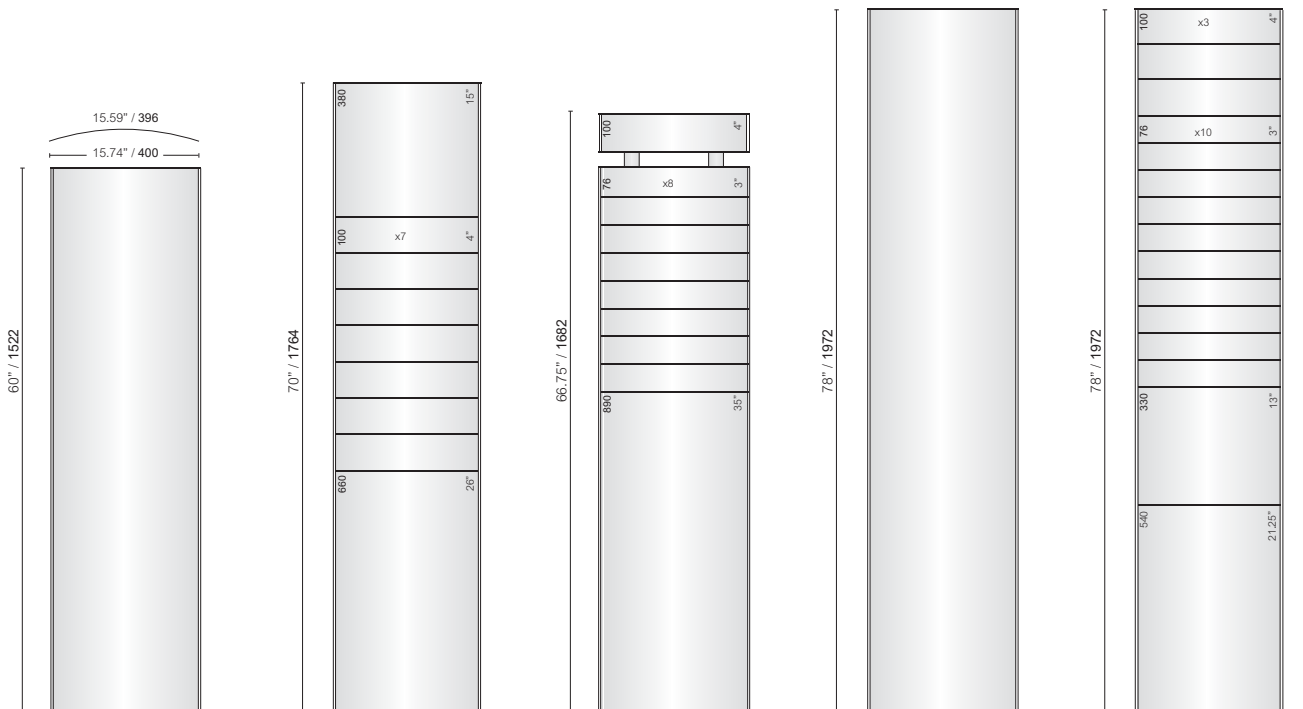

Floor mounted	DSS10 DSW10	DSS11 DSW11	- DSW12	DSS13 DSW13	DSS14 DSW14
Free standing	DSS10SA DSW10SA	DSS11SA DSW11SA	- DSW12SA	DSS13SA DSW13SA	DSS14SA DSW14SA

## Double Sided Pylons

Vista system offers a range of bases and end caps that utilize the built in screw bosses allowing all sign holders to be assembled using only a screwdriver. This feature of the system is used to create freestanding convex, double-sided signs to be used with standard sign substrates, without interior illumination.

A wide range of sizes can be fabricated by expanding the extrusions to fit the standard bases and end caps.

The wide design is offered in 19 different widths from 150mm/6" to 1200mm/48" and can be ordered in various heights to accommodate a wide range of applications.



Bases are available for both permanent and portable applications.



10EN-PH34

Standard finishes for Vista profiles and metal end caps are available in silver or black anodize.

Custom sizes and finishes are available upon request.

- Freestanding Base 
- Floor Mounted Base 



10EN-PH34A



Slim design - DSS



Wide design - DSW

V500

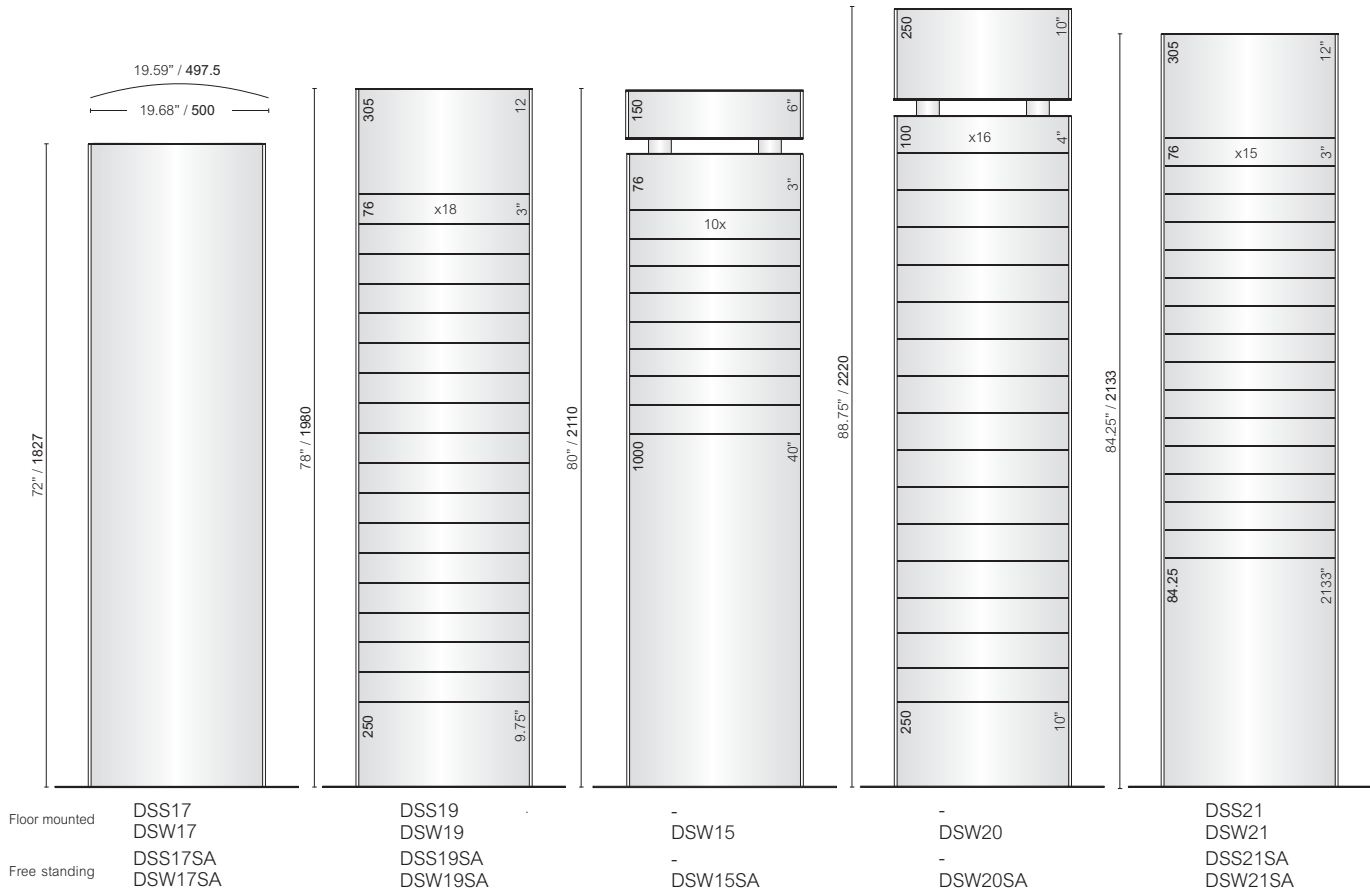

V600

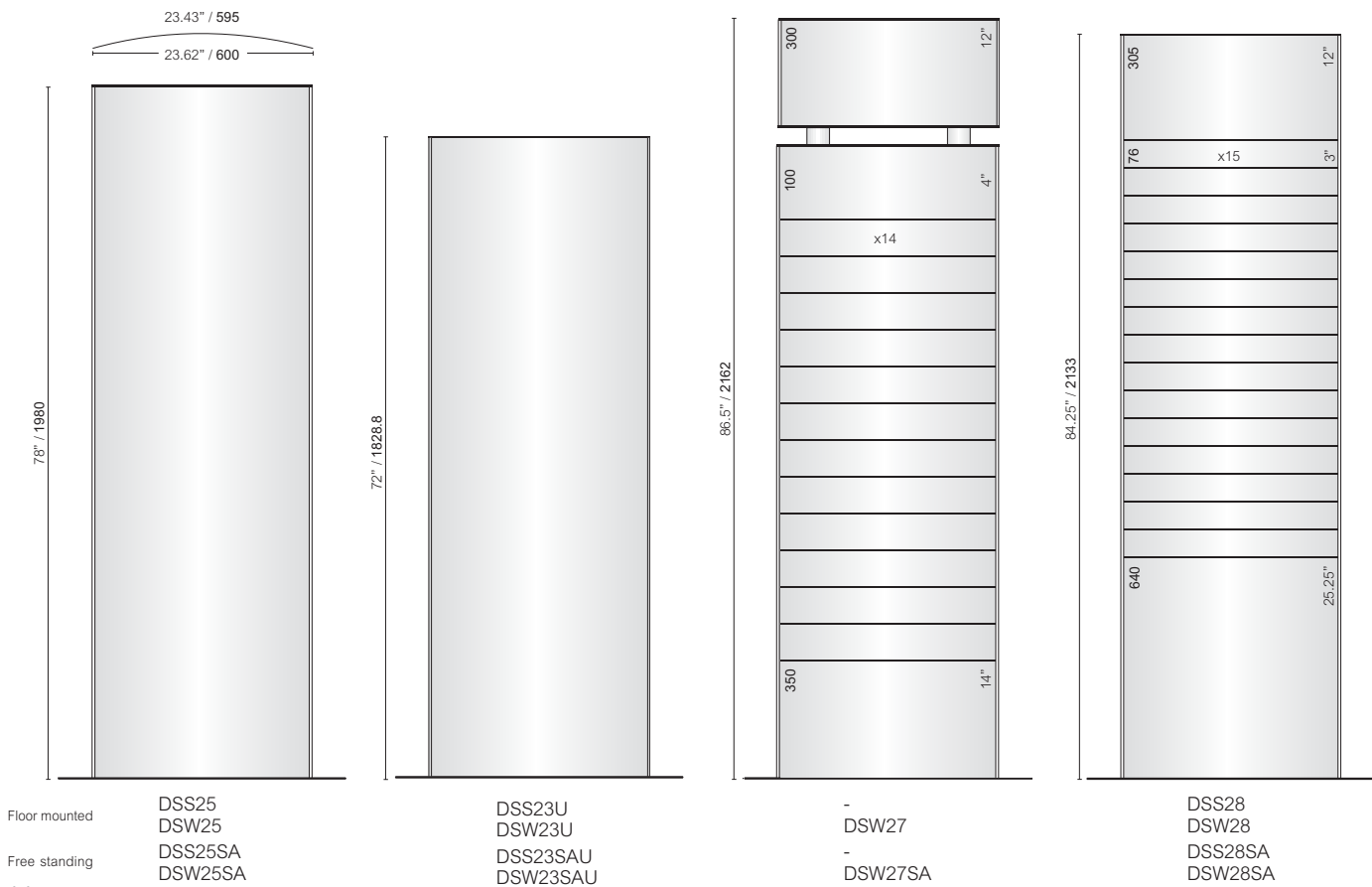



## Suspended Signs

Vista System standard profiles and end caps are used with specially designed connectors that are also cable clamps, to create unending combinations of vertical and horizontal curved double-sided suspended signs.

Suspended sign system from Vista System is fast and easy to install by even a novice.



10EN-PH36A



10EN-PH36B

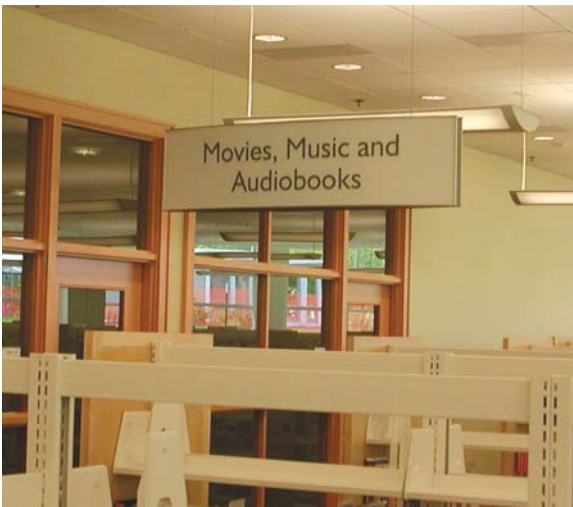

10EN-PH36C



10EN-PH36D



10EN-PH36E



10EN-PH36F

Standard finishes for Vista profiles and metal end caps are available in silver or black anodize.

Custom sizes and finishes are available upon request.

V60	SUS85 2.28" / 58 2.36" / 60 14" / 355	SUS1 16" / 400	SUS2 20" / 510	SUS3 24" / 610
V80	SUS4 3.07" / 78 3.14" / 80 16" / 400	SUS5 20" / 510	SUS6 24" / 610	SUS7 30" / 760
V100	SUS8 3.84" / 97.5 3.93" / 100 21" / 530	SUS9 24" / 610	SUS10 28" / 710	SUS11 32" / 810
V120	SUS13 4.72" / 120 4.72" / 120 22" / 560	SUS14 26" / 660	SUS15 30" / 760	SUS16 34" / 860
V150	SUS18 5.826" / 148 5.90" / 150 23" / 580	SUS19 28" / 710	SUS20 33" / 840	SUS21 38" / 970
V200	SUS22 7.8" / 198 7.87" / 200 20" / 510	SUS23 26" / 660	SUS24 32" / 810	SUS25 38" / 970
VA4	SUS26 8.27" / 210 8.46" / 215 11.75" / 297 A4	SUS27 20" / 510	SUS28 25" / 640	SUS30 40" / 1020
VLetter	SUS31 8.5" / 216 8.7" / 221 11" / 279.4 Letter	SUS32 20" / 510	SUS33 25" / 640	SUS35 40" / 1020
V300	SUS36 11.69" / 297 11.81" / 300 16.5" / 420	SUS86 20" / 510	SUS37 36" / 910	SUS38 48" / 1220
V400	SUS39 15.59" / 396 15.74" / 400 36" / 910	SUS40 48" / 1220	SUS87 52" / 1320	
V500	SUS41 19.59" / 497.5 19.68" / 500 26" / 660	SUS42 36" / 910	SUS43 48" / 1220	
V600	SUS44 23.43" / 595 23.62" / 600 40" / 1020	SUS45 48" / 1220	SUS88 52" / 1320	
AA				



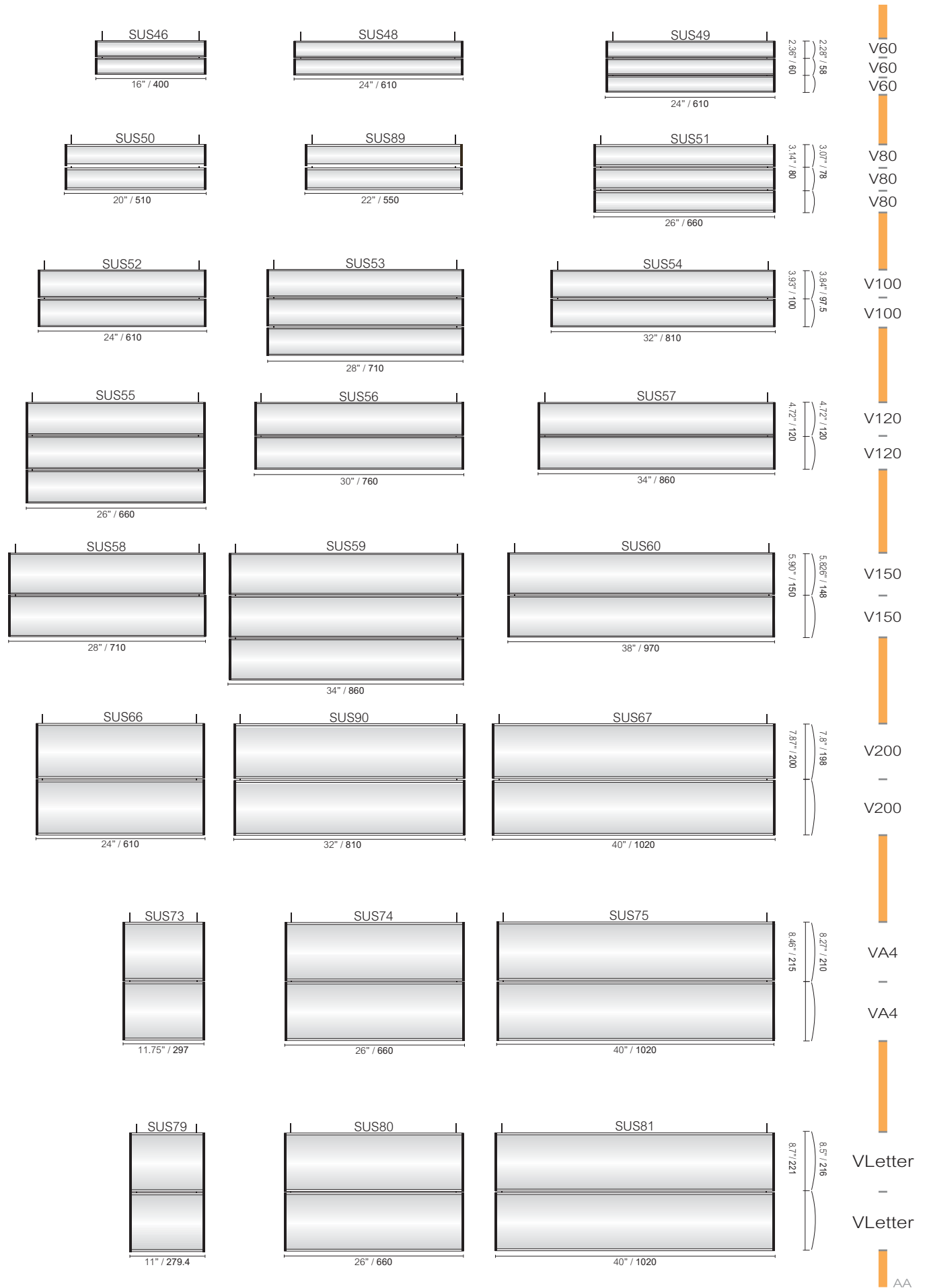

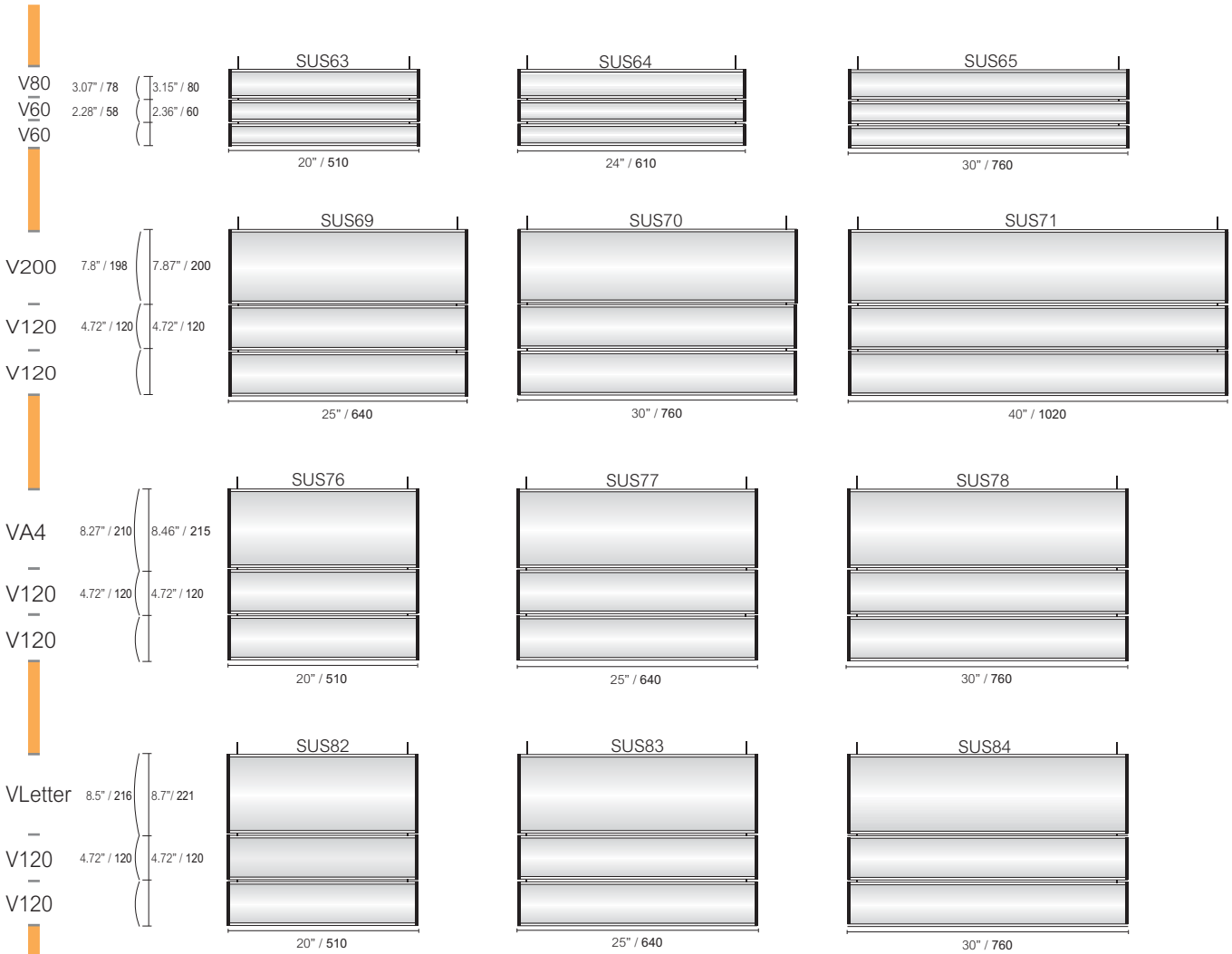

Suspended signs - Horizontal Curve

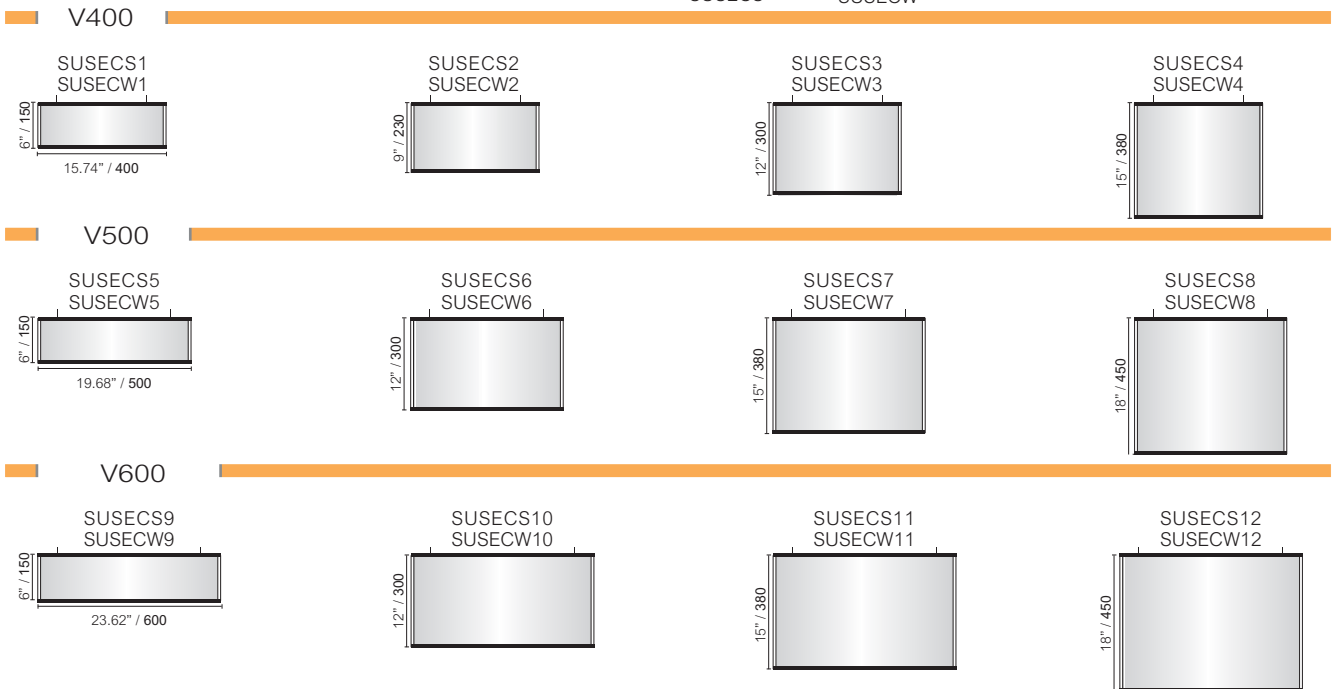
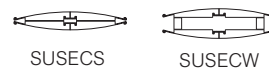

## Suspended Vista Light

The Vista Light series provides a great solution for suspended signs with or without internal illumination. The system is lightweight and available in a variety of sizes. Simply insert any flexible material between the extrusions.

The Vista Light system provides solutions for both horizontal and vertical curve configurations.



10EN-PH40



10EN-PH40A

Standard finishes for Vista profiles are available in clear or black anodize. Choose between black plastic end caps or silver and black anodize aluminum. Custom sizes and finishes are available upon request.

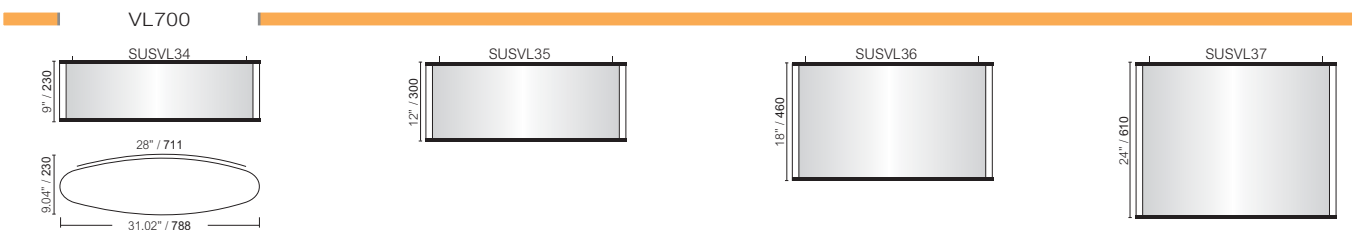
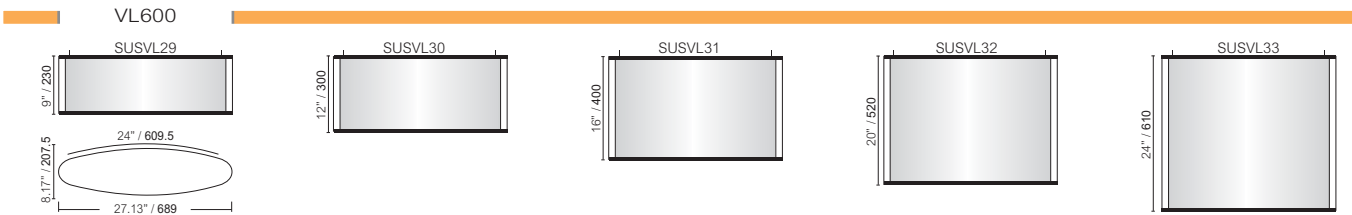
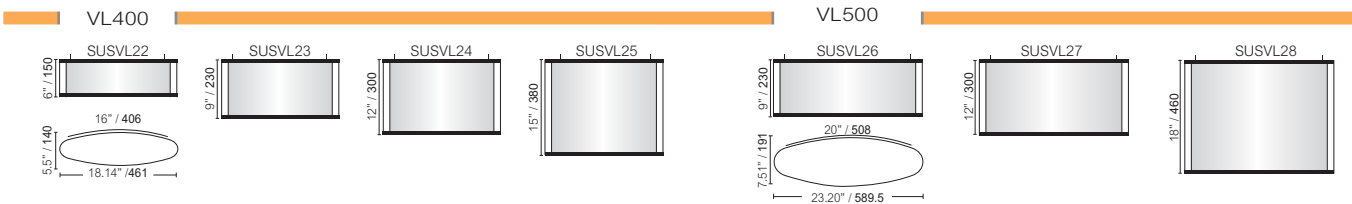

## Double Sided Post Signs

Vista's stylish posts are shown supporting a double sided sign with side-by-side posts, all Vista sign holders accept any sign material that is flat and flexible!

Sign frames and base heights are adjustable. Post components can be used in combination with the system's wide selection of standard parts.

Bases are available for both permanent and portable applications.



10EN-PH42

Standard finishes for Vista profiles and metal end caps are available in silver or black anodize.

Custom sizes and finishes are available upon request.



10EN-PH42A

VA4

VLetter

V300

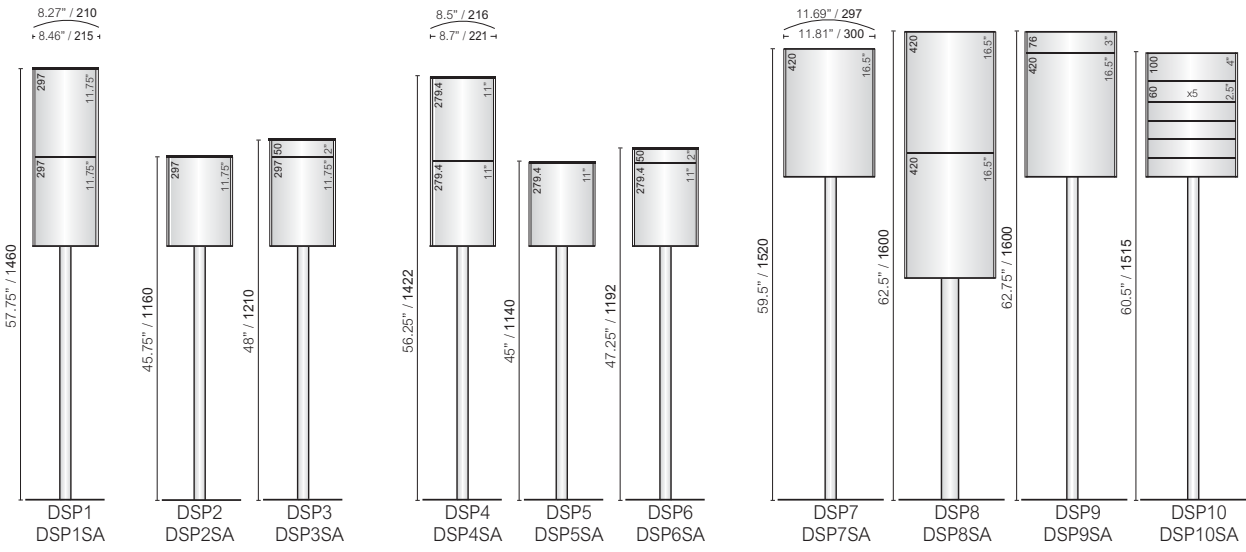

Floor mounted  
Free standing

V400

V500

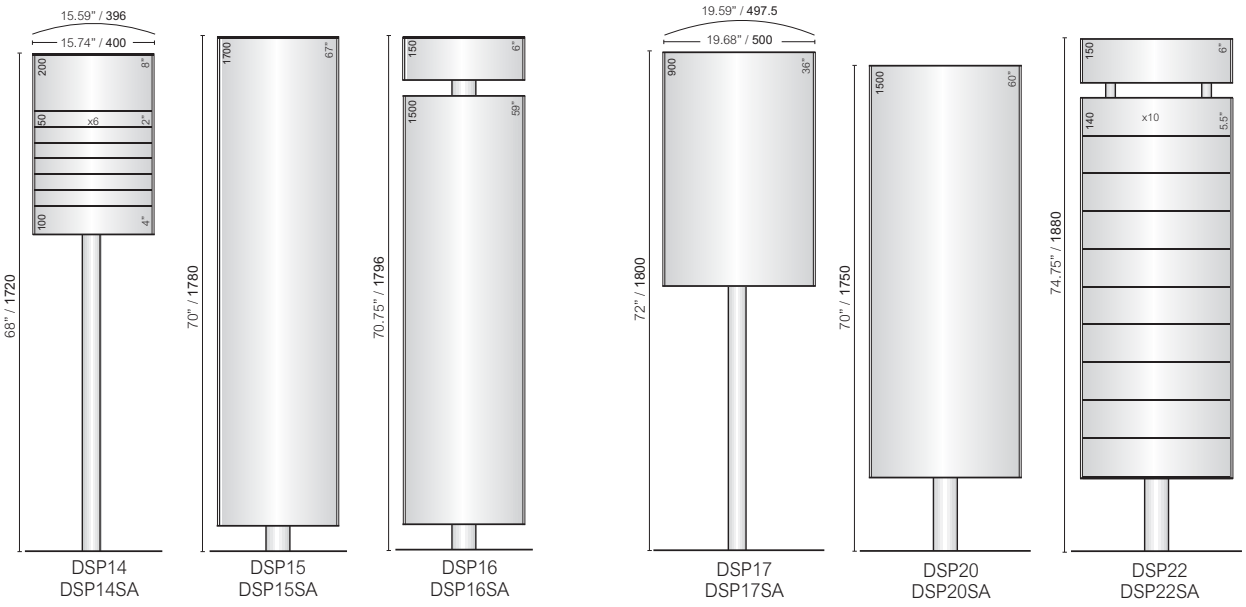

Floor mounted  
Free standing

V600

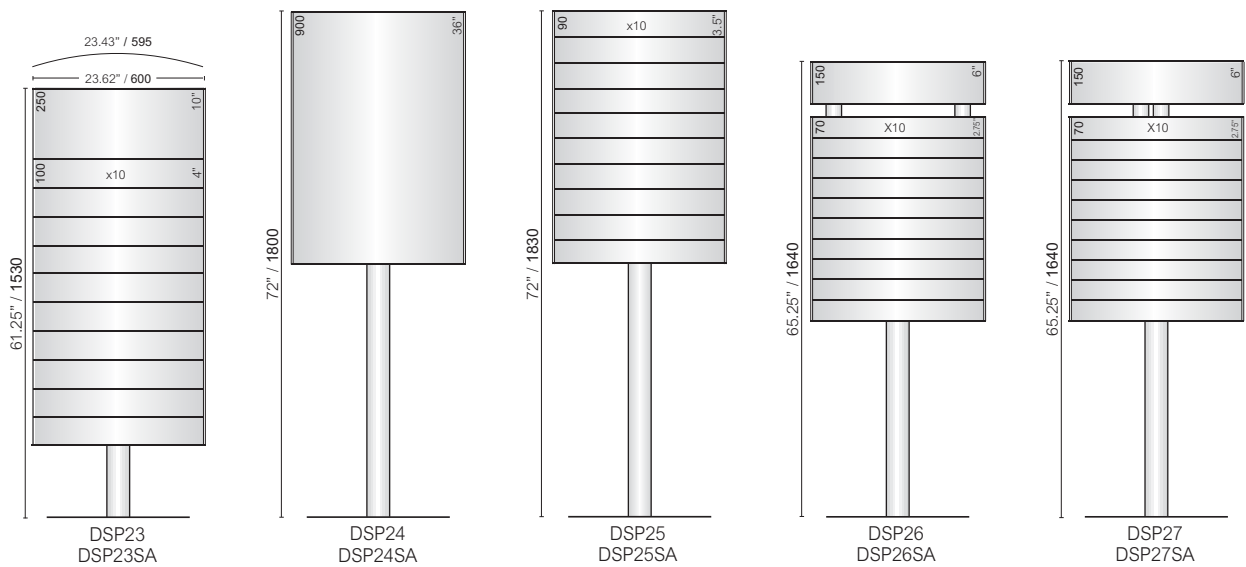

Floor mounted  
Free standing



## Triangular Post Signs

A triangular freestanding sign utilizes a short post section and a matching base to support the main triangular directory element. An additional post section is used to set the header apart from the main element.

10EN-PH44



10EN-PH44A

Vista Posts are available in 4 diameters. The system can be ordered in various heights to accommodate a wide range of application.

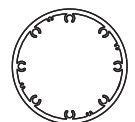

ø40mm/1.57"    ø60mm/2.36"    ø80mm/3.14"    ø100mm/3.93"



V200



TRP1  
TRP1SA



TRP2  
TRP2SA

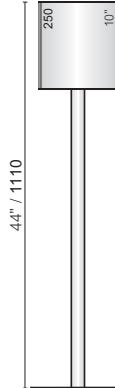

TRP3  
TRP3SA

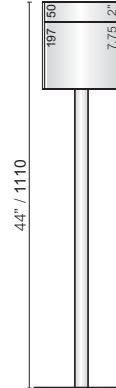

TRP4  
TRP4SA



TRP5  
TRP5SA

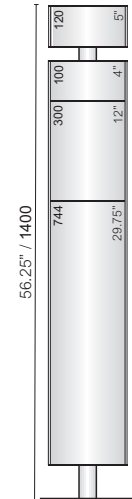

TRP6  
TRP6SA

Floor mounted  
Free standing

VA4

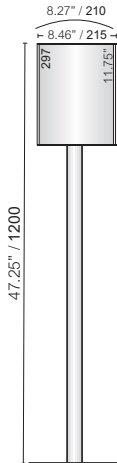

TRP7  
TRP7SA

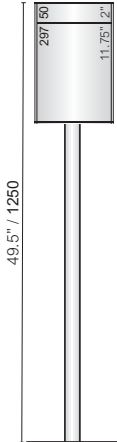

TRP8  
TRP8SA

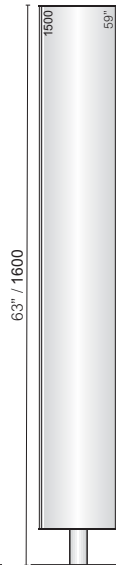

TRP9  
TRP9SA

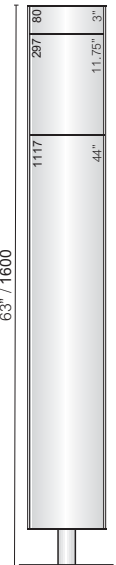

TRP10  
TRP10SA

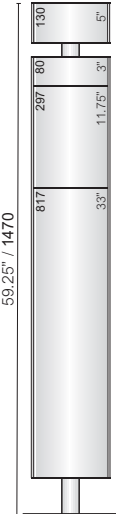

TRP11  
TRP11SA

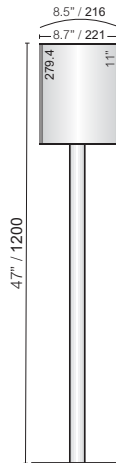

TRP12  
TRP12SA

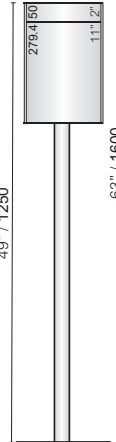

TRP13  
TRP13SA

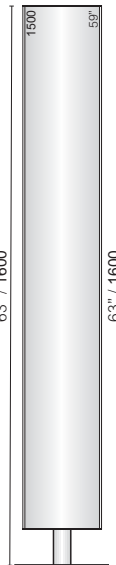

TRP14  
TRP14SA

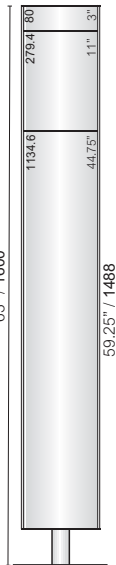

TRP15  
TRP15SA



TRP16  
TRP16SA

Floor mounted  
Free standing

VLetter

V300

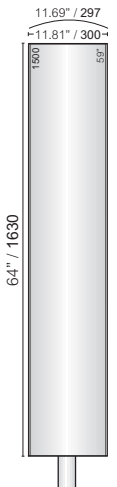

TRP17  
TRP17SA

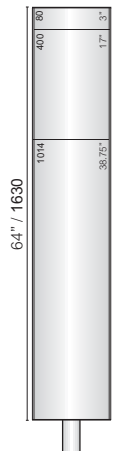

TRP18  
TRP18SA



TRP19  
TRP19SA

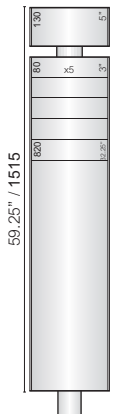

TRP20  
TRP20SA



TRP21  
TRP21SA

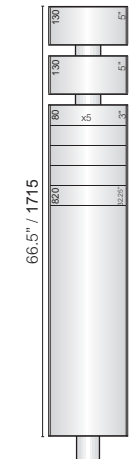

TRP22  
TRP22SA

## Vista Light Post Signs

A single post and base is shown supporting a double-sided Vista Light design. Sign frames and post heights are adjustable. It can be used with or without internal illumination.



10EN-PH46

## Vista Light - Post Sign

Easy to read, clear signs, that can be positioned to give maximum Information. They blend into the architectural design, while giving information that is simple to understand.



10EN-PH46A

VL250

VL300

VL400

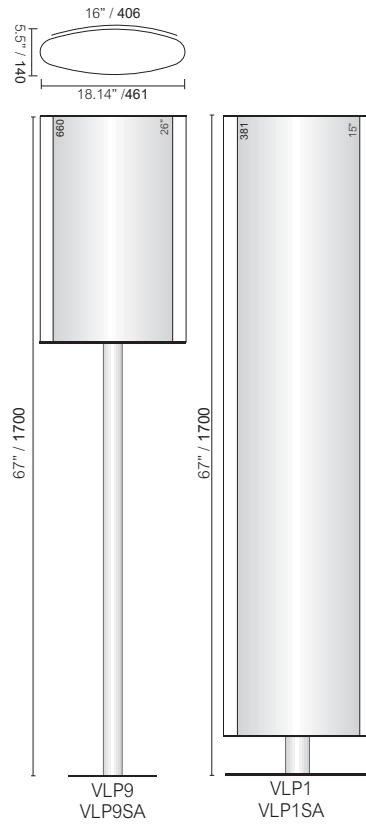
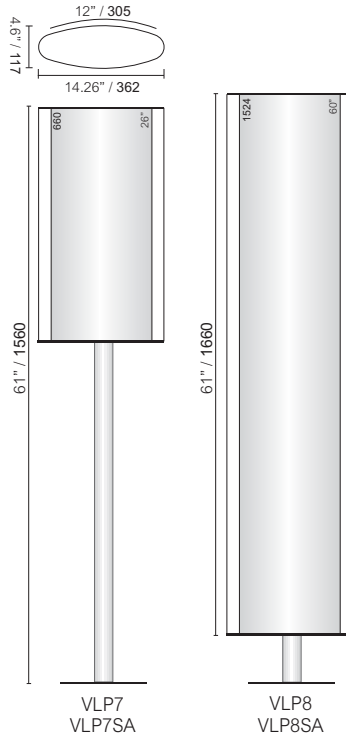
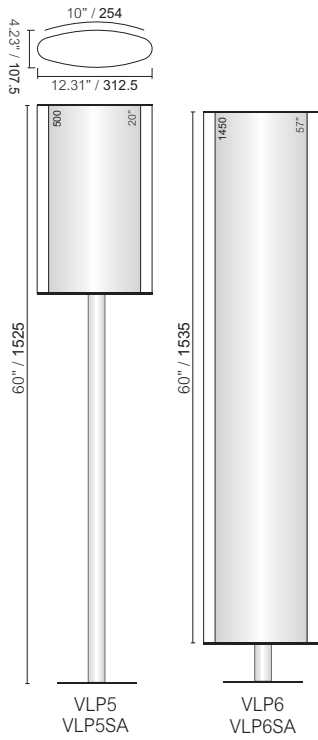

Floor mounted  
Free standing

VL500

VL600

VL700

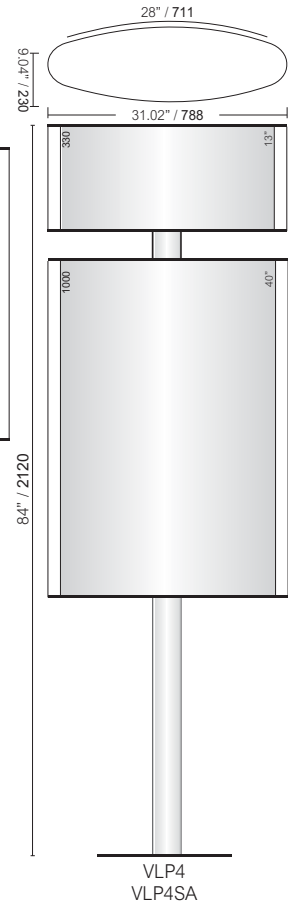
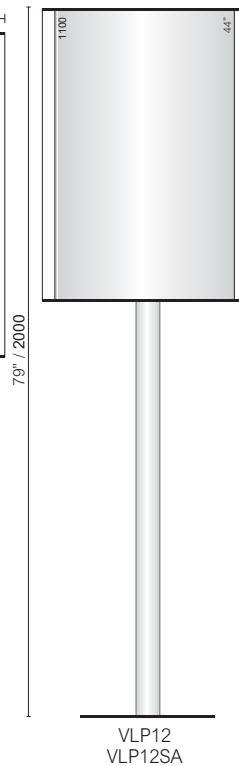
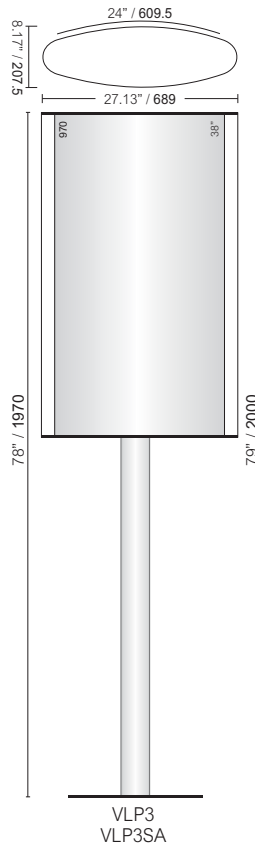
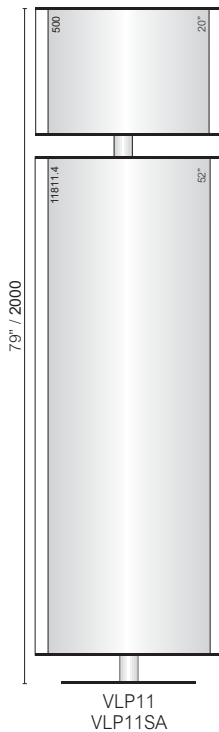
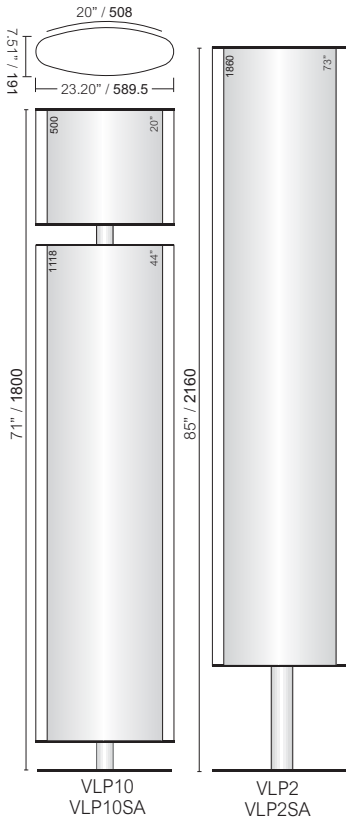

## Triangular Pylons

A triangular pylon, utilizing short sections of Vista post extrusions between frame sections to create an attractive way-finding system.

With Vista, customized signs are affordable. By using standard extrusions and components, custom designs are cost effective. Our staff will assist you in creating the product you need. Assembly is simple, and the only tool required is a screwdriver.

Bases are available for both permanent and portable applications.



10EN-PH48A



10EN-PH48B

Standard finishes for Vista profiles and metal end caps are available in silver or black anodize.

Custom sizes and finishes are available upon request.



10EN-PH48C

VA4

VLETTER

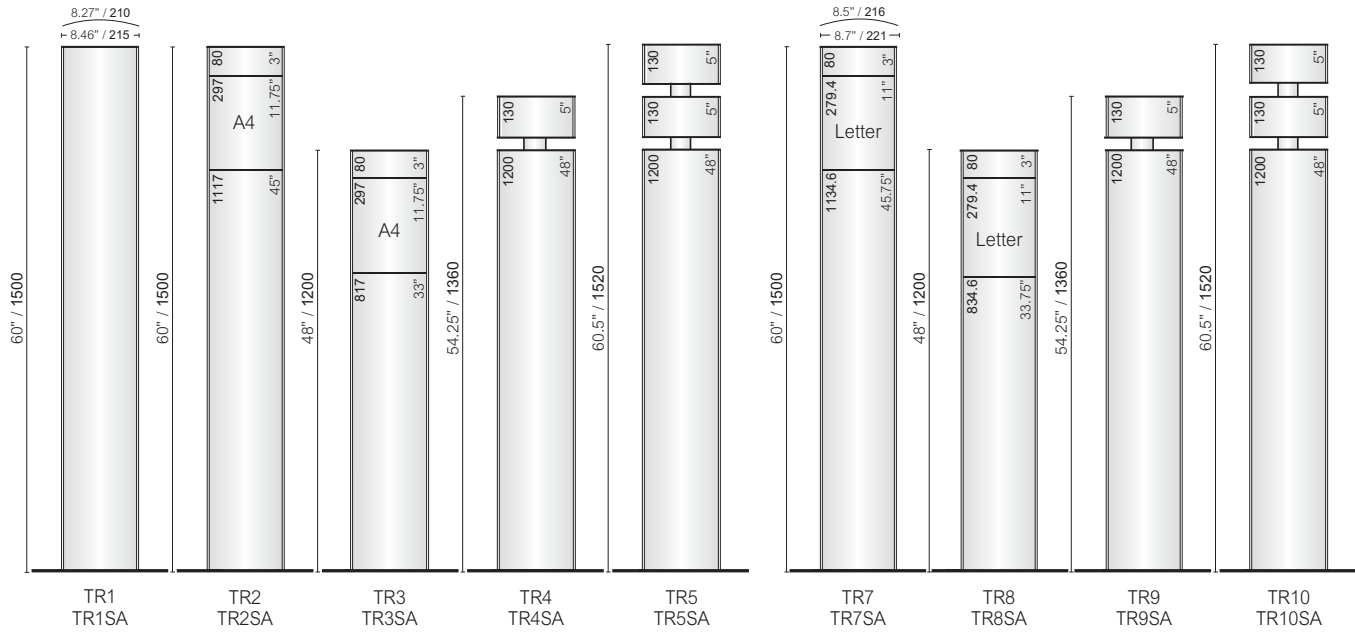

V300

V400

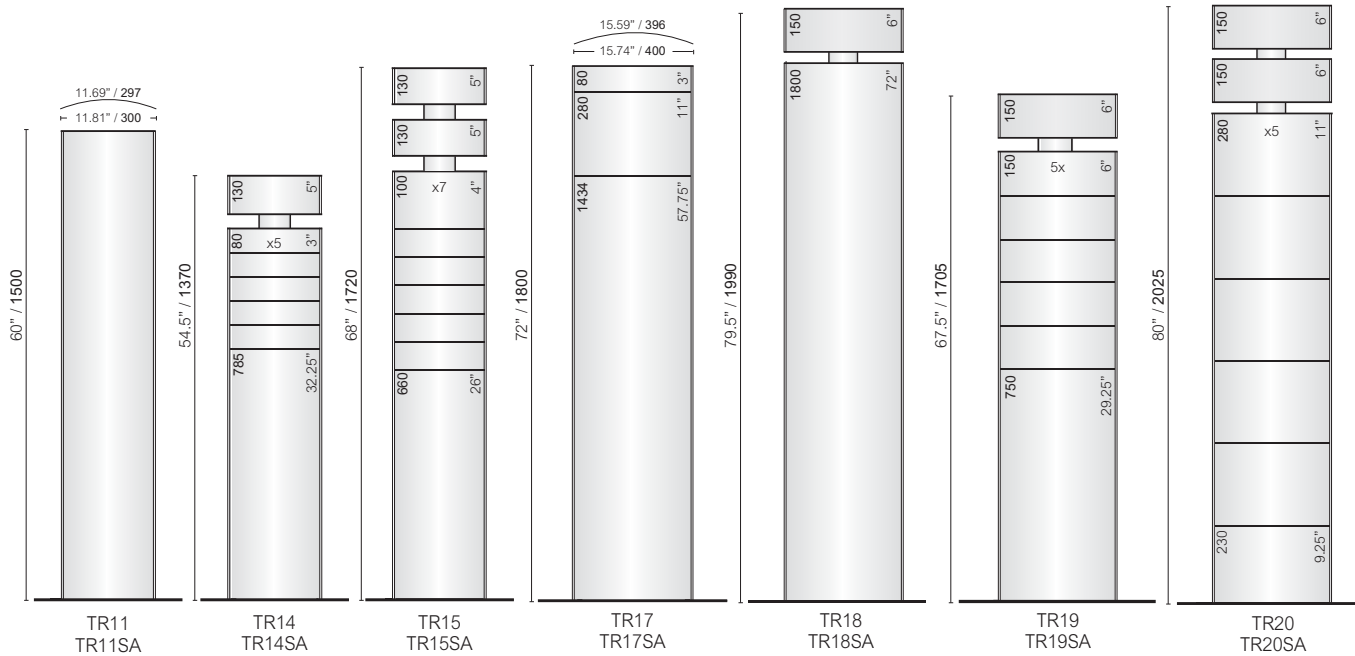



## Triangular Pylons

Create freestanding, convex triangular pylons using the standard Vista extrusions joined with a series of matching end caps and bases.

This cost effective frame system allows the use of standard substrates such as: plastics, metals, and paper. Create your own graphic signs and then flex and pop them in! When it's time to change the graphics, just pop them out again with the Vista Key suction cup.

The clear, non-glare lens provided by Vista can be used as a substrate for your vinyl graphics, or placed over printed paper inserts (paper should only be used indoors).

Bases are available for both permanent and portable applications.

Freestanding Base



Floor Mounted Base



10EN-PH50

Choose between 21 different widths from 100mm/4" to 1200mm/48", and can be ordered in various heights to accommodate a wide range of applications.



10EN-PH50A

V500

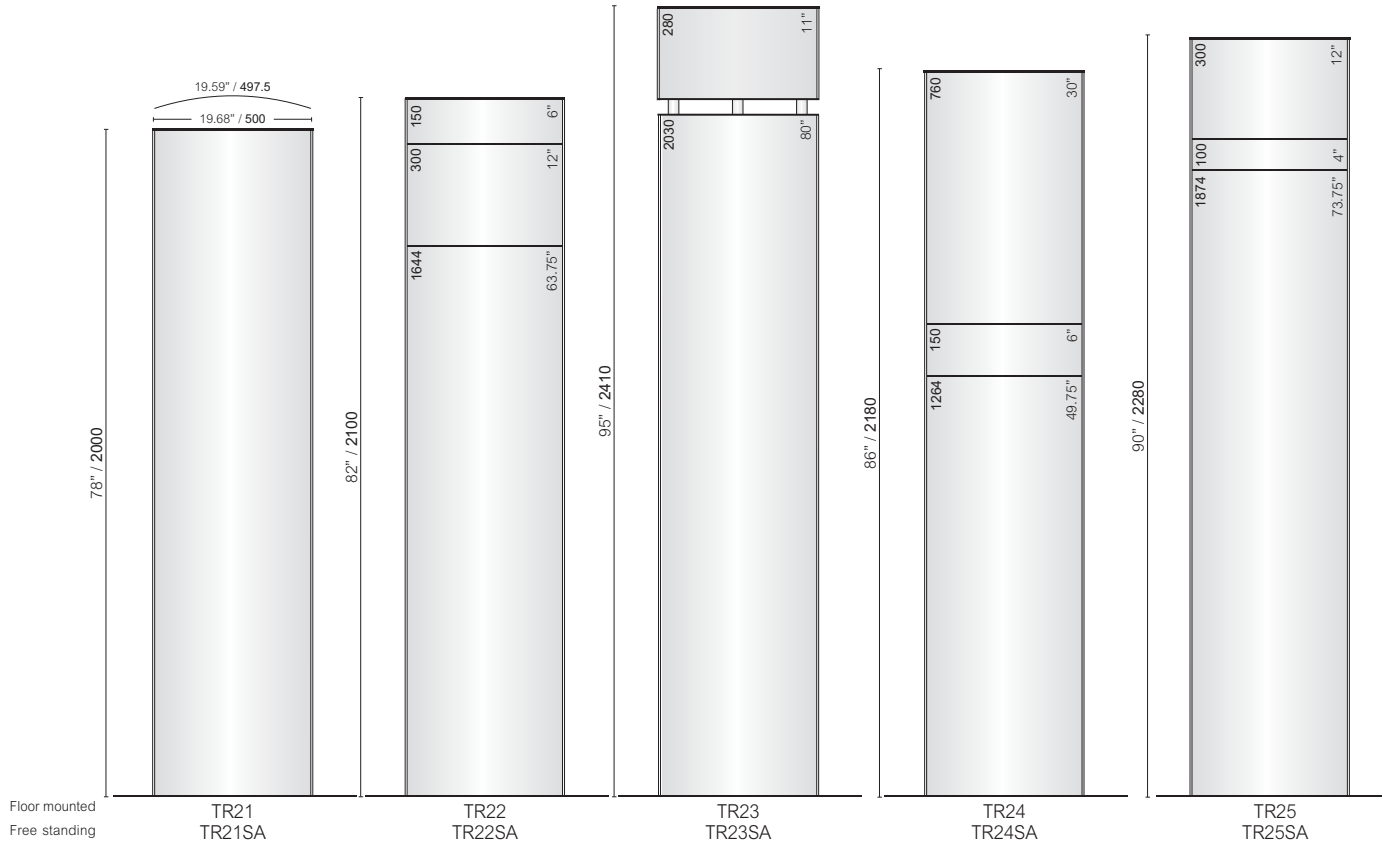

V600

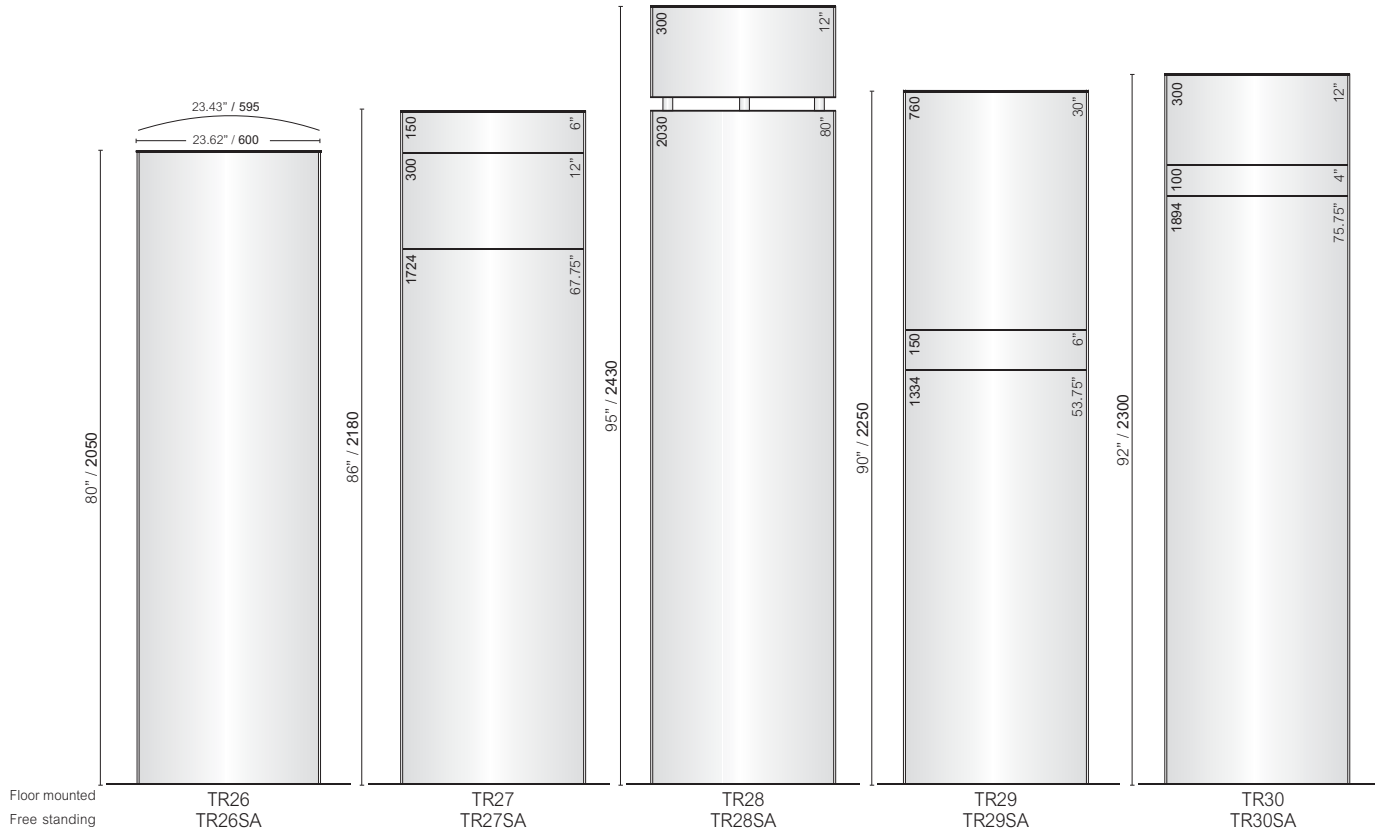



## Vista Light Pylons

This system is used to create freestanding, convex, double sided signs that can be backlit with the addition of interior illumination, or used with standard signs substrates without illumination.

The unique design of the system allows the use of two panels for inserting artwork that needs to be changed out often, such as posters.



10EN-PH52A



10EN-PH52B



10EN-PH52C



10EN-PH52D



10EN-PH52E

Standard finishes for VL1 and VL2 profiles are available in silver or black anodize.  
 Standard finishes for VL3 profile are available in silver paint or black anodize.  
 Choose between black plastic end caps or silver and black anodized aluminum end caps.  
 Custom sizes and finishes are available upon request.  
 Three profiles sizes: VL1, VL2, VL3, are the heart of the system.

VL250

VL300

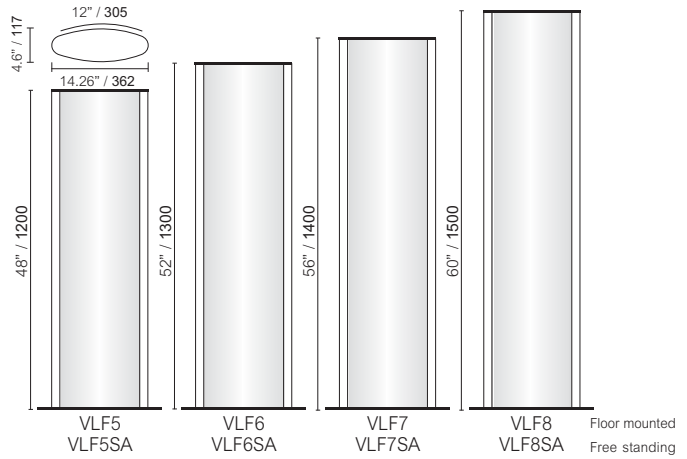
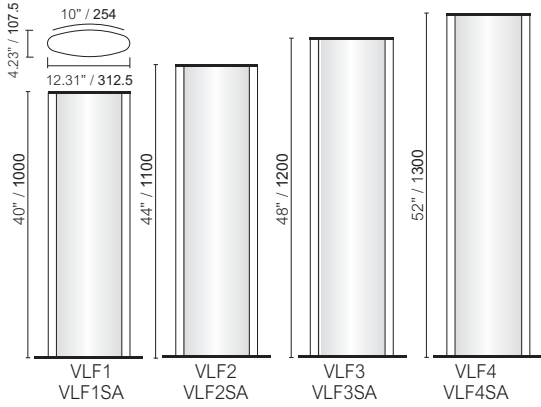

VL400

VL500

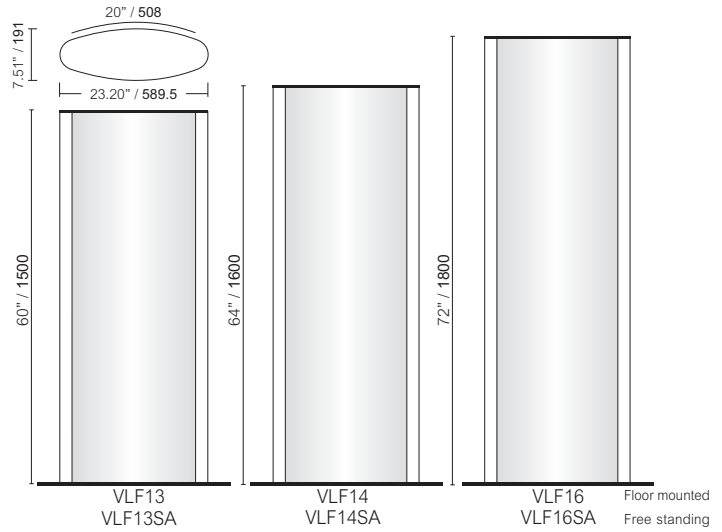
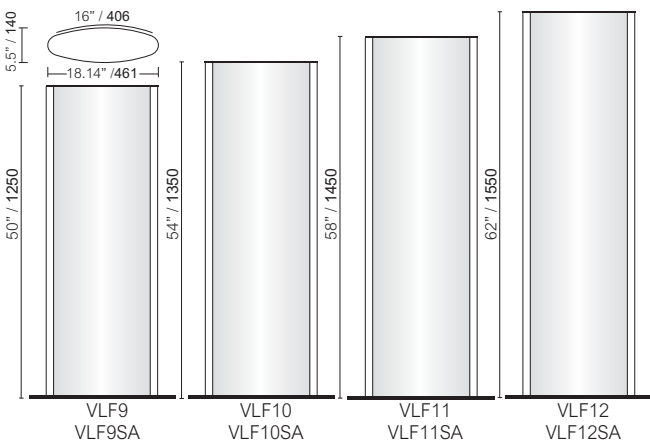

VL600

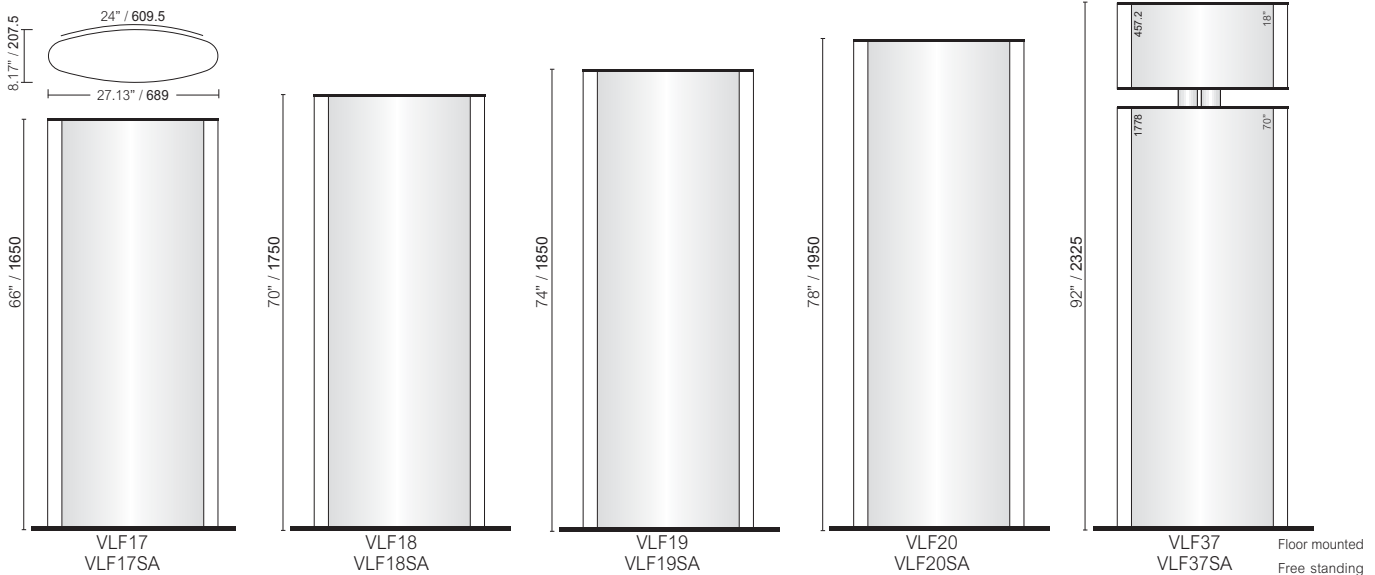

## Vista Light Pylons

Great for show rooms, lobbies, displays, parking garages, advertising, point of purchase, shopping centers, trade shows etc.

Bases are available for both permanent and portable applications.

This cost effective system is constructed from two special aluminum extrusions, an end cap, face inserts, and a base, for either portable, or permanent installation. The only tool needed for assembly is a screwdriver.



10EN-PH54



10EN-PH54A

The Vista Light sign frames are offered in ten different widths from 250mm/10" to 1200mm/48"

The system can be ordered in various heights to accommodate a wide range of applications.

VL700

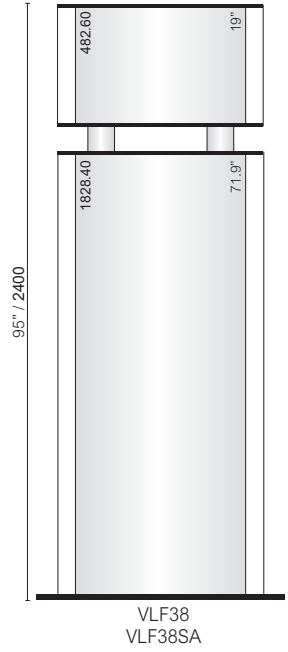
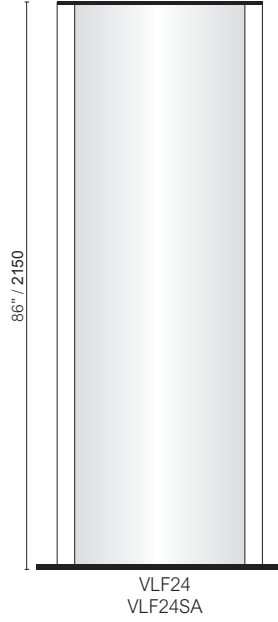
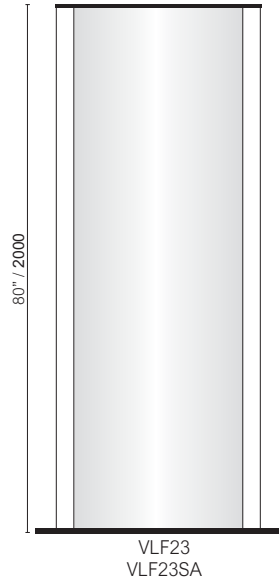
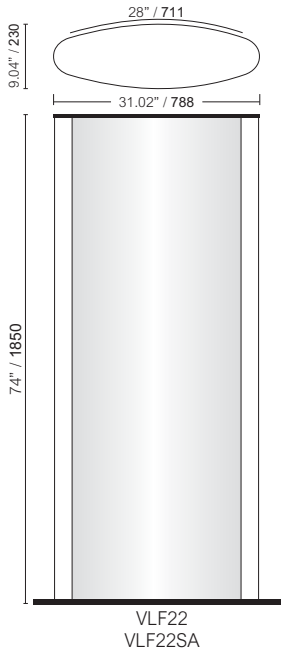

VL800

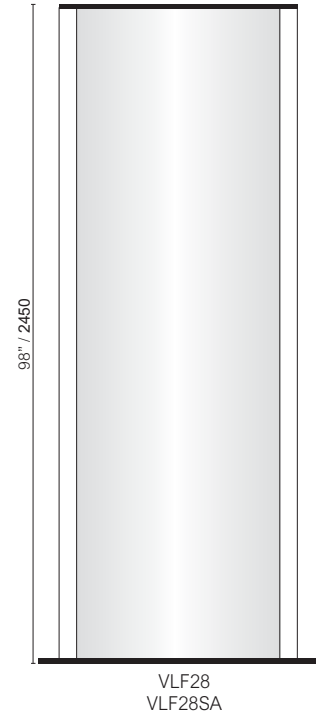
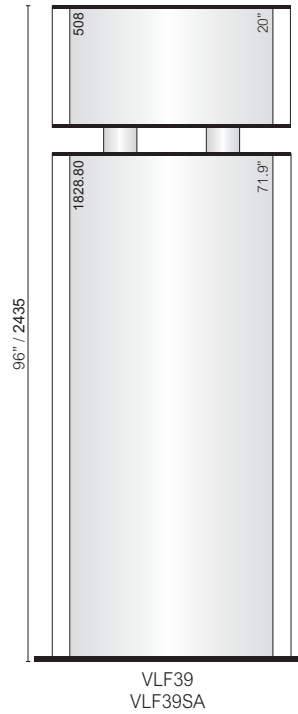
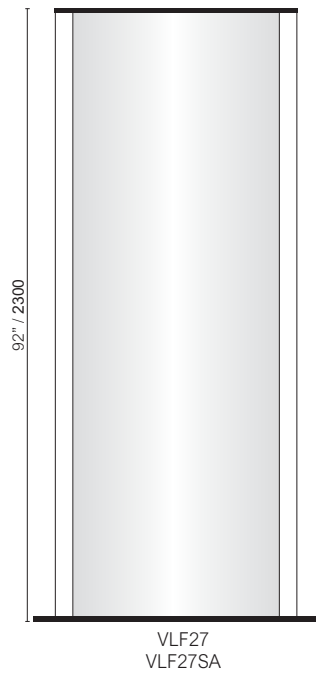
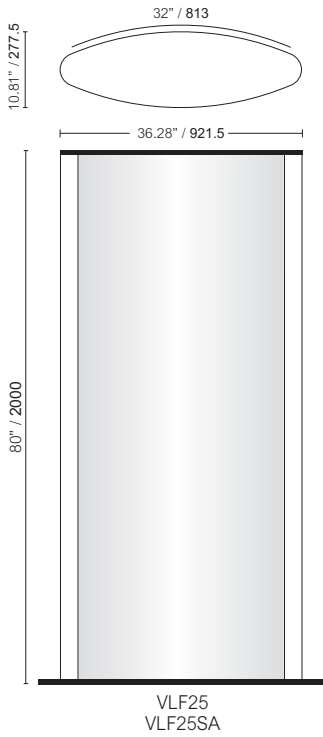

VL900

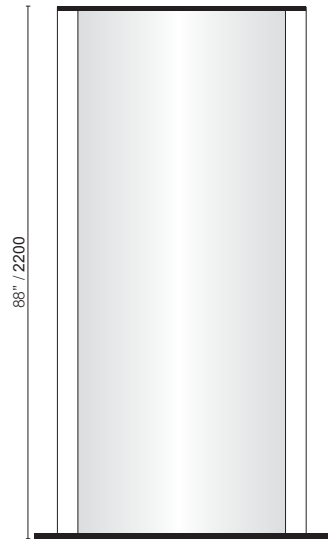
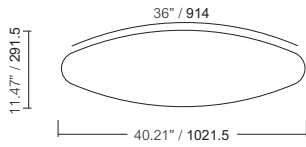

VLF30  
VLF30SA

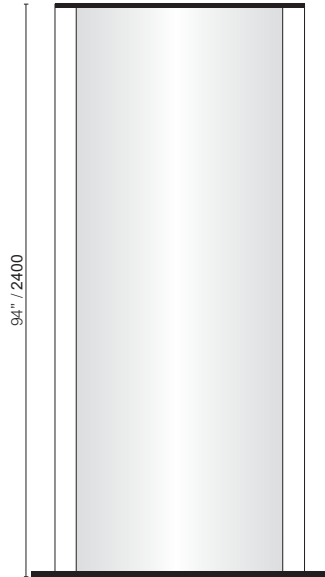

VLF31  
VLF31SA

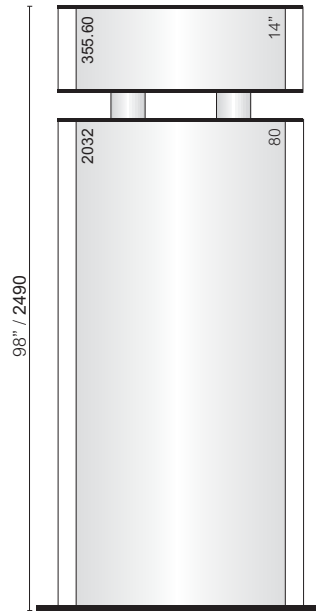

VLF40  
VLF40SA

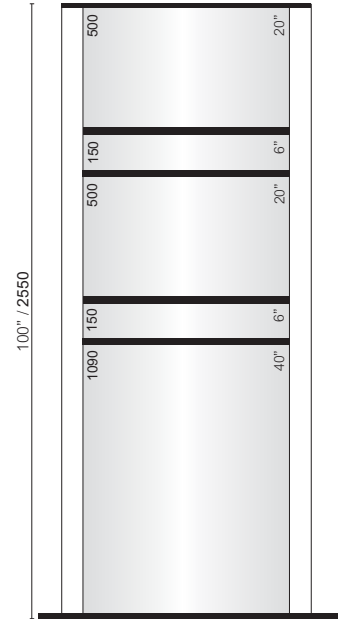

VLF32  
VLF32SA

Floor mounted  
Free standing

VL1000

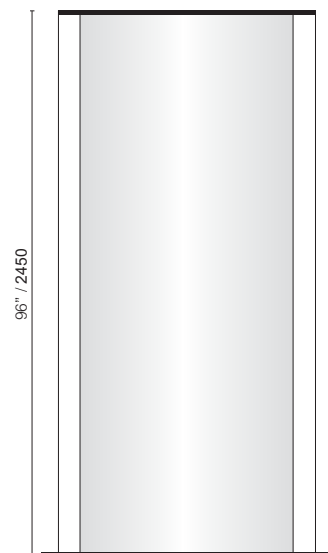
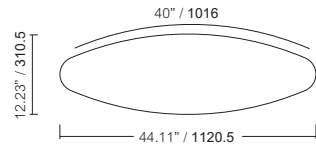

VLF33  
VLF33SA

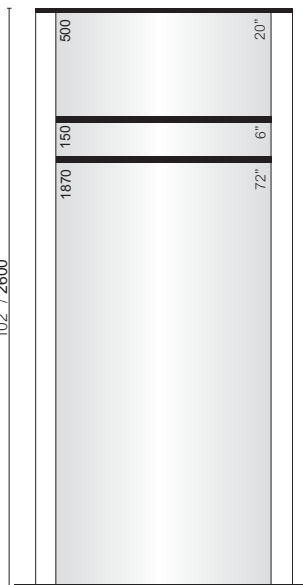

VLF34  
VLF34SA

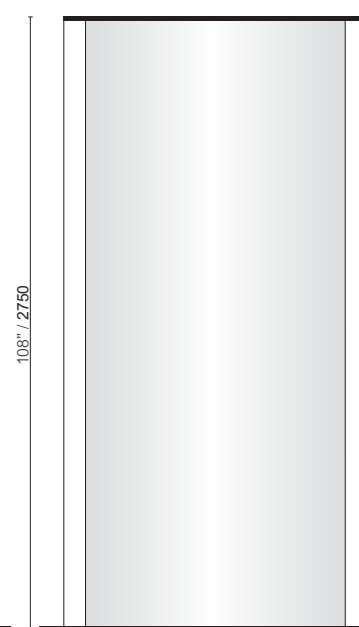
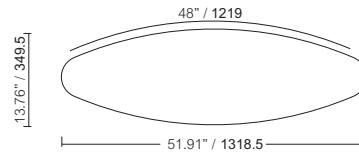

VLF35  
VLF35SA

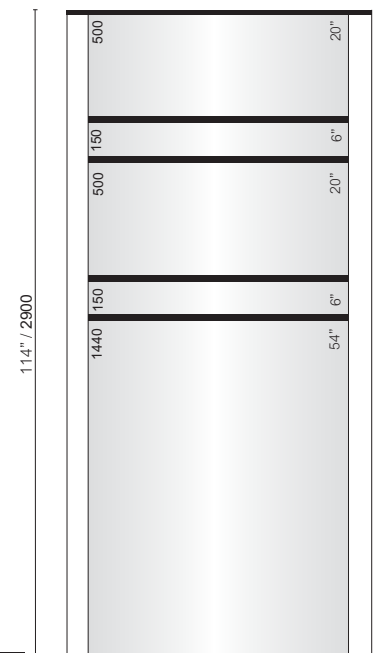

VLF36  
VLF36SA

Floor mounted  
Free standing



## C7 - Demonstration Kit

A professional and impressive sample case with eight different sign types, including graphics, the MCFT guidebook and a CD packed with sales and marketing tools to assist you in your presentations.

This kit is a must for your next sales call!  
P/N C7



## Custom Displays



Custom kits and samples are available upon request.

Special display kits are available to accommodate your needs and budget. Call for more information.

## Samples And Display Kits For The Sign Pro

### Why Samples and Display Kits?

Professional sales tools are one of the key factors in promoting your business. At Vista System, we have made a special effort to create sales sample kits to fit both your needs and budget. From our experience the most effective sales tool for Vista System is a display of actual signs presented in your business display area.

The display kits offered come with changable inserts, ready for you to provide the graphics of your choice.

We encourage you to experiment with different types of inserts to create an interesting and versatile display.

## C8 - Display Panel



### Showroom Display Board:

An attractive assortment of 8 Vista signs mounted on display board, ready to mount in your show room or lobby. This kit will enable you to show Vista System to your potential customers and add value to your current display area.

## Promo - Promotional Kit

100 customized samples to hand out to your customers, including the Vista suction tool. The samples are made of V80x3.14"/80mm or V100X 2.36"/60mm and include personalized graphics to include your company logo and information. There is a detailed label on the back of the sample with your company contact information. This is a great way to market and promote your company, with a practical and useful marketing tool that you leave with potential customers as a calling card.



10EN-PROMO100



10EN-PH58A



10EN-PH58B



10EN-PH58C



10EN-PH58D



Years from now, you may not be able to remember the precise moment you chose Vista System for your project. However, one thing you will remember: Our promise of reliability, because Vista System is designed to fulfill that promise. Vista System components are built to last and stay worry free.

For The Complete Vista Experience Log On Now!

[www.vistasystem.us](http://www.vistasystem.us)



# Bookmarks

www.vistasystem.us

Gallery:



<http://xrl.us/jxhz>

Video Clips:



<http://xrl.us/u4wf>

Latest Sign Projects:



<http://xrl.us/u4wg>

Ambassador Program:



<http://xrl.us/u4wh>

Shows and Events:



<http://xrl.us/u4wi>

We mean it!



<http://xrl.us/u9jq>

Press Releases



<http://xrl.us/u4wk>

Custom MCFT Signs Solutions



<http://xrl.us/u4wm>

System Components

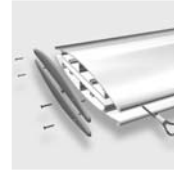

<http://xrl.us/vbnn>

A complete solution for all your way finding needs



We do it your **Wayfinding**

Copyright © Vista System. All rights reserved

Vista System

1800 N East Ave. Unit 102,  
Sarasota, FL, 34234, USA

- Phone: (800) 468-4782; (941) 365-4646
- Fax: (888) 316-5198; (941) 955-2681
- E-mail: [usa@vistasystem.com](mailto:usa@vistasystem.com)
- Web Site: [www.vistasystem.us](http://www.vistasystem.us)

MCFTGB-10EN0407

w w w . v i s t a s y s t e m . c o m

